

SHIBAURA INSTITUTE OF TECHNOLOGY

**A DESIGN METHODOLOGY
FOR DEVELOPMENT OF
CLINICALLY COMPLIANT
UPPER LIMB SPASTICITY
PART-TASK TRAINER**

**NOOR AYUNI BINTI CHE ZAKARIA
MARCH 2016**

SHIBAURA INSTITUTE OF TECHNOLOGY
GRADUATE SCHOOL OF ENGINEERING & SCIENCE

MARCH 2016

DOCTORAL DISSERTATION

**A DESIGN METHODOLOGY FOR
DEVELOPMENT OF CLINICALLY
COMPLIANT UPPER LIMB
SPASTICITY PART-TASK TRAINER**

Name	NOOR AYUNI BINTI CHE ZAKARIA
Student ID	NB13104
Major	Functional Control System
Department	Graduate School of Engineering & Science
Supervisor	Prof Takashi Komeda

CONTENTS

LIST OF FIGURES.....	iv
LIST OF TABLES	vi
LIST OF PUBLICATIONS	vii
ABSTRACT.....	ix
ACKNOWLEDGEMENT	x
CHAPTER 1.....	11
INTRODUCTION.....	11
1.1 Problem Statement	13
1.2 Research Objective	14
1.3 New Findings Knowledge	15
1.4 Significance of Research	16
1.6 Scope and Limitation	17
1.7 Outline of Thesis	17
CHAPTER 2.....	21
LITERATURE REVIEW	21
2.1 Simulator in Education	21
2.2 Therapy Education	22
2.3 Design Methodology for Medical Training Devices	28
2.4 Articulation of Upper Limb	30
2.5 Spasticity	31
2.6 Modified Ashworth Scale for Spasticity Assessment	33
2.7 Modified Tardieu Scale for Spasticity Assessment	38
CHAPTER 3.....	40
METHODOLOGY.....	40
3.1 Research Framework	40
3.2 Research Method	42
CHAPTER 4.....	46
QUESTIONNAIRE-BASED SURVEY	46
4.1 Survey Method	46
4.2 Survey Results	49

4.2.1	Therapists' Response towards Current Therapy Education	49
4.2.2	Therapists' Response towards Therapy Training Simulator	50
4.2.3	Implementation of the Upper Limb Spasticity Part-task Trainer	50
4.3	Discussions	51
CHAPTER 5	54
CONSENS™ PRINCIPLE SOLUTION	54
5.1	Model-Based System Engineering	54
CHAPTER 6	74
CLINICAL DATABASE	74
6.1	Clinical Data Measurement	74
6.1.1	Measurement Set-up	75
6.1.2	Subjects Screening	80
6.2	Clinical Data Analysis	81
6.3	Clinical Data Results	83
6.3.1	Results on Comparison MAS Level	85
6.3.2	Intra-rater reliability analysis	88
6.3.3	Determination of angular velocity for fast stretch threshold	92
6.4	Discussions	93
CHAPTER 7	95
SPASTICITY MODELLING	95
7.1	Spasticity Mathematical Modelling	95
7.2	Modelling Simulation Results	100
7.3	Discussions	103
CHAPTER 8	105
PROTOTYPE DEVELOPMENT	105
Following the initial shape discussed in	105
8.1	Hardware System	106
8.2	Software System	109
8.3	Evaluation Experiment Set-up	111
8.4	Evaluation Results	113
8.5	Discussions	117
CHAPTER 9	119
CONCLUSION AND RECOMMENDATION	119
9.1	Summary	119

9.2 Recommendation & Future Work	121
9.3 Conclusions	124
REFERENCE.....	126
APPENDICES.....	131

LIST OF FIGURES

Figure 1 Illustration of study flow for bachelor degree in physiotherapy and occupational therapy	12
Figure 2 Illustration of pronation around fixed humerus (Donald A. Neumann. <i>Kinesiology of the Musculoskeletal System – Foundation for Physical Rehabilitation</i> . Mosby, Inc. 2002 [34]).....	31
Figure 3 Illustration of Front End Product Development Process for upper limb spasticity part-task trainer	41
Figure 4 Research activities based on the stakeholders' voices throughout the design process	43
Figure 5 Partial model for the domain-spanning description based on the specification technique CONSENS TM	44
Figure 6 (a) Therapists' responses towards questions in Section A: Current Therapy Education, (b) Therapists' responses towards questions in Section B: Training Simulator.....	49
Figure 7 Therapists' response towards Question 6	50
Figure 8 Illustration of proposed new curriculum	52
Figure 9 Partial models for the domain-spanning description of the principle solution of advanced mechatronic systems.....	56
Figure 10 Functions of upper limb spasticity part-task trainer	58
Figure 11 Behaviour states for upper limb spasticity part-task trainer	59
Figure 12 Behaviour activities of Upper limb spasticity part-task trainer.....	61
Figure 13 Specification of the active structure taking into account the stakeholder's voices	62
Figure 14 Ellipse orbit of wrist extension effect.....	63
Figure 15 Moveable ulna structure and radius angle movement.....	64
Figure 16 Cam follower at the elbow joint.....	65
Figure 17 Angle Range of Artificial Human Arm Simulator	66
Figure 18 Application A: Slow stretch haptic feedback for all MAS level	68
Figure 19 Application B: MAS 1 fast stretch haptic feedback.....	69
Figure 20 Application C: MAS 1+ fast stretch haptic feedback p1	70
Figure 21 Application C: MAS 1+ fast stretch haptic feedback p2.....	71
Figure 22 Application D: MAS 2 fast stretch haptic feedback	72
Figure 23 Application E: MAS 3 fast stretch haptic feedback.....	73
Figure 24 Flowchart of experimental protocol	76
Figure 25 Measurement of devices set-up connection for the clinical data collection.....	77
Figure 26 Goniometer - joint angle sensor attached to metal stationary arm	77
Figure 27 Attaching goniometer to the patient.....	78
Figure 28 Manual muscle tester.....	78
Figure 29 LabVIEW 8.6 screen during data recording.....	81
Figure 30 Sample of data analysis in MATLAB code.....	82
Figure 31 Results for Patient 4 with MAS 0 during slow and fast stretch.....	85
Figure 32 Results for Patient 12 with MAS 1 during slow and fast stretch.....	86
Figure 33 Results for Patient 14 with MAS 1+ during slow and fast stretch	87
Figure 34 Results for Patient 11 with MAS 2 during slow and fast stretch.....	88
Figure 35 Range of fast stretch angular velocity for each MAS score	91
Figure 36 Range of slow stretch angular velocity for each MAS score	92
Figure 37 Sample of patient's data with MAS1+ to show calculation of spasticity characterised parameters	98
Figure 38 MATLAB Programming flowchart for spasticity simulation	99

<i>Figure 39 Simulation results of fast extension MAS1+ spasticity (Patient 9)</i>	100
<i>Figure 40 Simulation results of fast extension MAS1+ spasticity (Patient 10)</i>	101
<i>Figure 41 Simulation results of fast extension MAS1+ spasticity (Patient 14)</i>	102
<i>Figure 42 Simulation results of fast extension MAS1+ spasticity (Patient 15)</i>	103
<i>Figure 43 Actuator and sensor configuration for upper limb spasticity part-task trainer</i>	105
<i>Figure 44 The incremental encoder for angle and angular velocity data acquisition sensor</i>	106
<i>Figure 45 Arduino Mega 2560 Controller</i>	107
<i>Figure 46 DC Motor Driver 2X15A Lite with 2 PWM output pins</i>	108
<i>Figure 47 Arduino IDE software structure</i>	109
<i>Figure 48 Add-in Microsoft Excel GUI Parallax Data Acquisition (PLX-DAQ) tool</i>	110
<i>Figure 49 The Strain gauge module [SEN77631Y3]</i>	111
<i>Figure 50 Dummy arm prototype used to evaluate the programming system</i>	112
<i>Figure 51 Illustration of dummy prototype evaluation by experience physician</i>	112
<i>Figure 52 Prototype results of slow stretch MAS1+ spasticity 1st Trial</i>	113
<i>Figure 53 Prototype results of slow stretch MAS1+ spasticity 2nd Trial</i>	114
<i>Figure 54 Prototype results of fast stretch MAS1+ spasticity 1st Trial</i>	115
<i>Figure 55 Prototype results of fast stretch MAS1+ spasticity 2nd Trial</i>	116
<i>Figure 56 Sabertooth Dual 12A motor driver product by Dimension Engineering Inc.</i>	123

LIST OF TABLES

<i>Table 1 Comparison between four researches conducted on upper limb patient simulator.....</i>	<i>25</i>
<i>Table 2 Classifications of medical devices according to US and Japan regulations</i>	<i>29</i>
<i>Table 3 Comparison between Ashworth Scale and Modified Ashworth Scale Assessment</i>	<i>34</i>
<i>Table 4 Illustration of general pattern of Modified Ashworth Scale (MAS) in quantitative hypothesis</i>	<i>35</i>
<i>Table 5 Descriptions for Modified Tardieu Scale</i>	<i>39</i>
<i>Table 6 List of identified stakeholders.....</i>	<i>41</i>
<i>Table 7 List of questions provided in the questionnaire-survey</i>	<i>47</i>
<i>Table 8 Number of participants involved in the survey based on age group.....</i>	<i>52</i>
<i>Table 9 Application scenarios to emulate spasticity symptoms.....</i>	<i>67</i>
<i>Table 10 Diagnostic data for study participants</i>	<i>83</i>
<i>Table 11 Description of the cause of spasticity</i>	<i>84</i>
<i>Table 12 Intra-class Correlation Coefficients Description; ICC (model, type)</i>	<i>89</i>
<i>Table 13 Intra-rater reliability summarised in Intra-class Correlation Coefficient agreement.....</i>	<i>90</i>
<i>Table 14 Number of subjects participated for each MAS level</i>	<i>93</i>
<i>Table 15 Clinical data parameter sets of spasticity emulation for MAS1+.....</i>	<i>98</i>

LIST OF PUBLICATIONS

Journals

- [1] N. A. C. Zakaria, T. Komeda, C. Y. Low, F. A. Hanapiah, K. Inoue, R. Dumitrescu, and A. Kuehn, "Value Driven Design of A High Fidelity Part-task Trainer for Upper Limb Disorders," *Jurnal Teknologi*, vol. 76, pp. 31-36, 2015. **(Scopus)**
- [2] N. A. Othman, N. A. C. Zakaria, C. Y. Low, F. A. Hanapiah, T. Komeda, and K. Inoue, "Towards A Clinically Compliant Upper Limb Part-task Trainer in Simulated Learning Program," *Jurnal Teknologi*, vol. 76, pp. 71-76, 2015. **(Scopus)**
- [3] N. A. C. Zakaria, et al., "Emulating Upper Limb Disorder for Therapy Education," *Int J Adv Robot Syst*, vol. 11, 2014. **(Scopus)**
- [4] N. A. Che Zakaria, et al., "Evaluation of Upper Limb Spasticity towards the Development of a High Fidelity Part-task Trainer," *Procedia Technology*, vol. 15, pp. 818-827, 2014. **(Scopus)**
- [5] N. A. C. Zakaria, et al., "Emulation of Spasticity Symptoms in Upper Limb Part-Task Trainer for Physiotherapist Education," *Applied Mechanics and Materials*, vol. 393, pp. 999-1004, 2013. **(Scopus)**
- [6] N. A. Che Zakaria, T. Komeda, and C. Y. Low, "Design of Upper Limb Patient Simulator," *Procedia Engineering*, vol. 41, pp. 1374-1378, 2012. **(Scopus)**

International Conference Proceedings/Papers

- [1] "Spasticity Mathematical Modelling in Compliance with Modified Ashworth Scale and Modified Tardieu Scales," in 15th International Conference on Control, Automation and Systems (ICCAS 2015), BEXCO, Busan, Korea, 2015, (in press). **(IEEE Conf)**
- [2] N. A. C. Zakaria, T. Komeda, C. Y. Low, K. Inoue, and F. A. Hanapiah, "Model-Based System Engineering of Upper Limb Spasticity Part-Task Trainer," presented at the 9th South East Asian Technical University Consortium (SEATUC) Symposium, Nakhon Ratchasima, Thailand, 2015. **(Conf. Paper)**
- [3] N. A. C. Zakaria, T. Komeda, C. Y. Low, K. Inoue, and F. A. Hanapiah, "A Questionnaire-Based Survey: Therapist's Response towards the Upper Limb Disorder Learning Tool," in XII International Science Conference, Istanbul Turkey, 2014, pp. 1791-1793. **(Conf. Proceeding)**
- [4] C. Z. Noor Ayuni, et al., "Emulation of muscle tone of upper limb spasticity and rigidity," in 6th International IEEE/EMBS Conference on Neural Engineering (NER), 2013 San Diego, CA, 2013, pp. 1590-1593. **(IEEE Conf)**
- [5] N. A. CZ, et al., "High-fidelity Part-Task Trainer of Upper Limb Disorder for Physiotherapist Education," in 12th WSEAS International Conference on SIGNAL PROCESSING, ROBOTICS and AUTOMATION (ISPRA '13) Cambridge, UK 2013, pp. 165-170. **(Conf. Proceeding)**

ABSTRACT

The aim of this research is to develop a model-based system engineering, specifically for designing a high fidelity upper limb spasticity part-task trainer occupied with varying levels of severity in spasticity symptoms, with reference to the Modified Ashworth Scale and Modified Tardieu Scale. The design method was based from the Value-driven Design and Front End Product Development process for medical devices, combined with the specification technique of CONSENSTM. The part-task trainer will focus on providing a learning tool for therapists, physicians, and clinicians to repetitively engage in training, thus lessen patient involvement. The part-task trainer is developed to follow the structure of the human arm articulation, including the ability to emulate spasticity stiffness. A set of clinical database of spasticity patients was collected from Hospital Sungai Buloh, Malaysia. A spasticity mathematical modelling was then developed to simulate the characteristics of a human arm, followed by the development of a programming system using Arduino program. This thesis further elaborated the clinical data, simulation data, and the prototype evaluation to recreate spasticity stiffness.

Keywords: Model-based system engineering, part-task trainer, Modified Ashworth Scale, Modified Tardieu Scale, spasticity, therapist training tool

ACKNOWLEDGEMENT

I would like to express my deepest appreciation to my supervisor, Professor Takashi Komeda, who continuously and convincingly conveyed a positive vibe towards conducting this research and the excitement of finding new experiences in a learning adventure. Without his supervision and constant help, this research and dissertation would not have been possible.

I would like to thank my committee members, Dr.-Ing Low Cheng Yee from the Faculty of Mechanical Engineering, Universiti Teknologi MARA, who has helped me build a mechatronic system design, Dr. Fazah Akhtar Hanapiah from the Faculty of Medicine, Universiti Teknologi MARA, whose contribution included helping me with clinical data collection, and Associate Professor Kaoru Inoue from the Division of Occupational Therapists of Tokyo Metropolitan University, for her continuous encouragement in helping me complete this research.

My special gratitude goes out to my husband Mohd Sawaldi Alwai for inspiring me to complete this work, and my family for all the sacrifices they have had to make as I achieve my dreams. A very special thank you to my colleagues, Dr. Aizreena Azaman, Hanif Ramli, Azmi Patar, Dr Azuwan Mat Dzahir, and Komeda Laboratories members for all the support they have given me over the years.

Thank you very much.

CHAPTER 1

INTRODUCTION

In scientific language, spasticity means an increase in muscle tone and enhanced tendon reflexes resulting from any brain and spinal cord injuries. It is a motor disorder described by a velocity-dependent increase in the muscle stretch reflex. In other words, spasticity implies stiffness or tightness in the muscle, giving resistance to the passive movement of the limb. Spasticity symptoms can be seen in spinal cord s and brain injuries such as stroke, multiple sclerosis, and cerebral palsy patients.

Commonly used methods in estimating spasticity levels are the Ashworth Scale (AS) and the Modified Ashworth Scale (MAS)[1, 2]. Both methods are straightforward and do not necessitate devices to perform the test. However, there are several uncontrolled factors that may affect the degree scores for spasticity levels, either from the patients or the therapists themselves, such as the activities engaged by the patients before the tests and the testing position. Therefore, it is essential for the raters or the therapists to have sufficient professional experience when working with these standardised methods [3]. In order to amplify the reliability and the precision of the rating level, the therapists need to increase the amount of clinical training and exposure to a variety of spasticity levels without putting

the patients at risk [4]. To avoid clinical training with patients, a part-task trainer which is able to recreate different levels of spasticity has been considered.

Physiotherapists coordinate and improve the balancing of the cardio-respiratory system and motor control for a better quality of life, while occupational therapists assist people in rehabilitation to overcome disability caused by injury or illness to function in daily life activities. Figure 1 illustrates the general career roadmap for a novice therapist from his or her bachelor degree towards becoming a board-certified occupational therapist or physiotherapist.

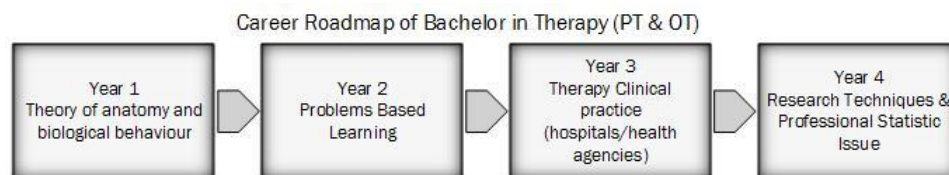

Figure 1 *Illustration of study flow for bachelor degree in physiotherapy and occupational therapy*

In the current therapy education, novice therapists are required to undergo therapy clinical practice in hospitals or health agencies during the third year of their undergraduate studies, with some limitations in patient numbers at the related hospitals/health agencies. This, in turn, raises the issue of lack of experience among the novice therapists. Additionally, there is a concern in increasing the frequency of training for novice therapists reported through a questionnaire-based survey by [5] regarding the reliability of the rater evaluation. It was reported that 72% of the surveyed participants believed that novice therapists need higher frequency of training before engaging with real patients during their 'clinical placement'. This concern is probably due to the inter-/intra-rater variability in the extension velocity of spasticity disorder [6].

It was reported in [7] that both medical students and educators considered simulator-based training as a must for all medical students. Further discussion was done regarding ethical issues of whether a simulation-based education is acceptable from the

perspective of the patients, learners, educators, and the society, with the essence of protecting patients whenever possible [8]. Based on the reports above, it is highly significant to develop training simulators or a part-task trainer for all medical fields, including therapy education to maximise the frequency of training while minimising risks. Thus, following the problem statements above, regarding a learning tool for novice therapists in spasticity assessment, an upper limb spasticity part-task trainer based on the Modified Ashworth Scale (MAS) and Modified Tardieu Scale was developed.

1.1 Problem Statement

Patients have the right to receive the best care that can be reasonably provided by any medical facilities. It is understood that therapists/clinicians-in-training will treat patients during their training, but from an ethical perspective, harm to patients as a by-product of training or lack of experience is justified only after maximising approaches that do not put patients at risk [8]. In the field of rehabilitation, physical and occupational therapists play an important role to reintroduce social life to patients who have been handicapped by diseases or physical impairments. This work proposes the development of an upper limb spasticity part-task trainer for the clinical teaching and learning processes.

Risk to Patient Safety: In order to qualify oneself in therapy, therapists and medical students need to have multidimensional knowledge base, where one of the concepts of therapy skills is the use of touch. As actual reflex response and tension of muscle cannot be sensed from a role-play training, physical therapists have to obtain their skills from clinical experiences encountered with patients. Thus, patients are used as the primary learning subjects during their clinical training. Though this has been common practice, it is no longer acceptable, due to the fact that new trainees can cause injuries to the patients. However, if learners are not permitted to make mistakes, they do not learn

how to recognise errors or to correct mistakes. This results in rigid thinking and an inability to adapt.

Variability in Spasticity Evaluation: Therapists evaluate the severity level of spasticity using the Tardieu, Ashworth, and Modified Ashworth Scales, which vary depending on their experience. Variability in rater scores currently happening between and within raters suggest that training can be improved. Current medical education demands better measurement of outcomes, as well as the accountability of diagnosis from the medical team, nursing and other healthcare practitioners.

Paradigm Shift in Medical Education: Those responsible for professional health education are finding that traditional educational models, which involve extensive clinical time, are not sustainable, and health organisations, health managers, and clinicians reportedly view students who are undergoing their clinical placement as a burden [9]. With an increasing number of students requiring training, the therapy profession is not immune to these challenges and has stated widely that there is a ‘clinical education crisis’. The burgeoning number of physiotherapy schools has raised concerns amongst the profession that the constrained healthcare sector cannot continue to deliver an appropriate level of experience to provide safe and effective graduates [10].

1.2 Research Objective

In order to counter the problem following therapy education field, a few objectives have been determined and are listed below:

- i. To develop a mechatronic design methodology to serve as a basis for first analysis and communication medium between interdisciplinary researchers, specifically in the development process of spasticity part-task trainer

- ii. To construct a spasticity clinical database focusing on the Malaysia region and investigate the quantitative characteristics of upper limb spasticity
- iii. To suggest a suitable upper limb spasticity mathematical modelling based on the collected clinical database and create a simulation module that will be embedded into the prototype
- iv. To develop an upper limb spasticity part-task trainer prototype, followed by an evaluation of the hardware/software integration

1.3 New Findings Knowledge

This research resulted from the basis of a mechatronic design methodology concept solution, exclusively for an upper limb spasticity part-task trainer that combine both hardware and software development and for medical devices in general. The novel principle solution attained from this research will lead to a new exploration as follows:

- i. Therapist perception towards the current therapy education according to frequency of training for novice therapists and inter-/intra-raters variability.
- ii. The importance of a model-based system engineering (MBSE) approach as an effective medium for medical education innovation process among interdisciplinary researchers.
- iii. Development of a simple and non-invasive upper limb spasticity measurement for clinical data collection purposes.
- iv. Exploration of upper limb spasticity characteristics at various levels in compliance with the Modified Ashworth Scale (MAS) and Modified Tardieu Scale (MTS).
- v. Formulation of a new upper limb spasticity mathematical modelling and programming.

1.4 Significance of Research

The proposed basis principle solution on mechatronic design system development for upper limb spasticity part-task trainer for education training shall provide a complete guideline for the development process of other medical training devices. Most of the development processes typically consist of interdisciplinary researchers who largely derive from the medical field, engineering background, business experiences, and not to mention the patients' point of view as part of the stakeholders' voices.

The part-task trainer was developed for the teaching and learning of spasticity, involving occupational therapists, physiotherapists, and rehabilitation physicians. It ensures patient safety and enables students to gain experience and build their confidence before engaging with real patients. At the same time, it solves the problem of patient unavailability, especially with the increasing number of students. By providing a safe and supportive environment for mastering skills, practicing protocols, and applying critical decision-making in the teaching and learning process, the part-task trainer inadvertently strengthens the therapists' confidence and promote competence.

On top of that, it leads to the improvement in educational practices and curriculum, while also providing new challenges to the curriculum planners. This research serves as a stimulus to consolidate a new medical simulation industry, in line with the National Key Economic Areas (NKEA) in healthcare. It cannot be denied that the use of simulation in healthcare is becoming an essential component in education, training, assessment, and the maintenance of professional certification. The positive impact in terms of improving patient safety, increasing medical reliability, reducing medical errors, and decreasing healthcare costs is far-reaching.

1.6 Scope and Limitation

- i. Mechatronic design methodology was built based on the Front End Product Development from Value Driven Design philosophy with the combination of CONSENS™ principle solution.
- ii. The spasticity clinical data measurement is conducted under the ethics approval granted by the Medical Research and Ethics Committee of the Ministry of Health Malaysia [Ref. NMRR-13-1384-18681 (IIR)] and the Research Ethics Committee of Universiti Teknologi MARA [Ref. 600-RMI (5/1/6)].
- iii. All measurements are collected through Vernier SensorDAQ for data acquisition using the LabVIEW software, and all sensory manipulations do not involve invasive procedures.
- iv. The mathematical modelling simulation program was coded in MATLAB language and an open-source electronics platform base, ARDUINO, is used to integrate the hardware and software.

1.7 Outline of Thesis

The title of this research is “A DESIGN METHODOLOGY FOR DEVELOPMENT OF CLINICALLY COMPLIANT UPPER LIMB SPASTICITY PART-TASK TRAINER”. This section briefly described the content of this research thesis, which consists of nine chapters, including Introduction, Literature Review, Methodology, Questionnaire-Based Survey, CONSENS™ Principle Solution, Clinical Database, Spasticity Modelling, Prototype Development, and the Conclusion and Recommendation.

Chapter 1: The first chapter provides a general introduction and background of the whole research, including problem statement, research objectives, the research significance, the scope and limitation, as well as an outline of the thesis.

Chapter 2: The second chapter elucidates the literature review, which describes previous studies related to this research. This chapter began with an introduction of the simulator in education and the current trends in the therapy education system. Then, it is followed by an introduction to the design methodology that was applied in the innovative processes of previous medical devices. After a detailed description of the articulations of upper limb, descriptions of spasticity characteristics was also included in this chapter. Finally, Chapter 2 will discuss the differences between Modified Ashworth Scale and Modified Tardieu Scale, which are used to assess spasticity severity.

Chapter 3: The third chapter describes the methodology of how the research is conducted. This chapter begins with the introduction of the research framework, which is based on the philosophy of Value Driven Design. This is followed by the discussion of the research method, which includes details of the four different phases of the Front End Product Development of Medical Devices: Discovery Phase, Envision Phase, Create Phase, and Refine Phase.

Chapter 4: In this chapter, the method to conduct the survey using questionnaire is explained. This chapter gathers the results from the questionnaire survey conducted on therapists and clinicians. The discussion includes responses from therapists and clinicians towards the current therapy education and the application of therapy training simulator in

the education system, with the possibility of its application in the teaching and learning process

Chapter 5: Chapter 5 clarified details of the design variable that was built through Model Based System Engineering called CONSENSTM. Each partial model is elucidated in details, beginning with the system functions, behaviour, active structure, and the part-task trainer system application scenario. The partial models are basic mechatronic design methodology.

Chapter 6: The sixth chapter focuses on clinical data collection. Clinical ethics application is conducted and explains the details of the setup and sample selection. This chapter is then further expanded with the analysis of spasticity clinical measurement results at several Modified Ashworth Scale levels, and to avoid bias results, an intra-rater reliability analysis is conducted and discussed.

Chapter 7: In Chapter 7, a mathematical modelling of spasticity symptoms is built based off the clinical data analysis. Following this is the comparison between the results of the previously developed mathematical modelling simulation and the clinical data. The success of emulating the spasticity MAS 1+ level through modelling simulation results is discussed at the end of the chapter.

Chapter 8: This chapter discusses the development of the upper limb prototype, with designs that include the hardware and software systems. An evaluation of the integration between the actuators selection in the hardware and software systems are conducted using a dummy upper limb prototype. At the end of this chapter, a comparison of the spasticity

characteristics pattern and the analysed results from the evaluation of hardware and software integration using the dummy prototype are discussed. Further argument is elaborated on the emulation of spasticity MAS 1+ level, based on the integration of the hardware and software systems and its limitations.

Chapter 9: The last chapter of this thesis explains the conclusion of the entire research discovery and provides future recommendations for forthcoming improvement of the new upper limb spasticity part-task trainer for the therapy and clinical education system.

CHAPTER 2

LITERATURE REVIEW

2.1 Simulator in Education

Simulator can be defined as a computer-controlled human mannequin or parts of the human body that is able to function as the human anatomy and react to the clinical procedures used during the training of the doctors, surgeons, nurses and therapists. The part-task trainer is able to simulate different situations and help trainees acquire new experiences and learn new clinical skills. Not only have simulators been used in education for medical practitioners [11] [12], but it has also been applied in educating young pilot to fly airplanes safely for decades [13] and helped veterinarians in clinical training as well [14]. Since the teaching and learning process in the clinical field deals with real patients of both humans and animals, it therefore poses plenty of challenges and the use of simulators is highly encouraged until the learners master the skills, thus avoiding catastrophic occurrences. Patient simulators have been used previously during clinical training in order to upgrade performances and skills in surgery [15], as well as anaesthesia. As a result, some of these uses have proven that a human patient simulator is able to develop good

performance among the trainees, even during complex field treatments such as trauma resuscitation [16]. The use of advanced human patient simulators encourages trainees to practice high-risk skills in a risk-free environment.

However, in therapy training, trainees still engage directly with patients to gain real-world experiences. A high-fidelity human patient simulator that is capable of helping them improve their skills and performance as discussed in [17] and [18] is still lacking. However, in order to be an expert in physical and occupational therapies, therapists need to have a multidimensional knowledge base, in which one of the concepts of therapy skills is the use of touch [19].

2.2 Therapy Education

With the aim of becoming a qualified therapist, individuals are required to complete an accredited therapy training programme before possessing a valid diploma or degree. Professional therapist regulations vary between countries, but must refer to particular regulatory bodies such as the World Confederation for Physical Therapy (WCPT), World Federation of Occupational Therapists (WFOT), and the Canadian Association of Occupational Therapists (CAOT). Therapist trainees need to undergo a theoretical part of therapy work such as anatomy and applying the theory they learn in the classroom to solve practical problems during Problem Based Learning (PBL). This is followed by clinical practice with patients in hospitals or related agencies, where they learn therapy techniques and assessment methods. Consequently, clinical practices have been discussed from different perspectives, with the focus in protecting the patients [8]. Some regulatory bodies have been promoting the Simulated Learning Programme (SLP), which usually consists of role-playing, e-learning programs, low-fidelity mannequins, part-task trainers, Standardized Patient actors, etc. [20] to create a patient-free environment.

This initiative is to enforce the repetition of practicing specific skills accordingly and consequently increases decision-making reliability such as in the Ashworth, Modified Ashworth, and Modified Tardieu Scales.

By pursuing the SLP in therapist training, four studies were reported to have developed patient simulators and part-task trainers for upper limb disorders (Table 1). Takashi Komeda et al. brought significant improvement in the training of medical practitioners with the development of an upper limb patient simulator in the clinical education field [21-23]. The research focused on developing an artificial human upper limb. The part-task trainer was built with one Degree Of Freedom (DOF) of active elbow joint and a passive shoulder joint. The elbow joint was able to flex and extend within the range of 140°, while connected by a cantilever mechanism of belt and pulley. The patient simulator was supported by a set of DC servo motor and Magneto-Rheological (MR) brake to emulate spasticity.

Aside from that, Hyung-Soon Park et al. produced a Haptic Elbow Spasticity Simulator (HESS) with the purpose of improving the accuracy and reliability of a clinical assessment of spasticity [4] [24]. The robotic system inspired the standardisation of clinical assessments of spasticity by means of recreating the haptic feedback of spasticity based on the quantitative measurements (position, velocity, and torque) collected from the subjects. A mathematical model was developed to program the haptic device and also to produce accurate joint torques at given input conditions. The accuracy and the reliability of the haptic model were validated by eight experienced clinicians who consisted of six physical therapists and two physicians. The results showed that the haptic assessment had high matching MAS scores. This proved that the HESS and the haptic model can provide a novel clinical analysis and training strategy for physiotherapist studies. However, in spite of the high evaluation for the prototype, the clinical data was collected from children

spasticity and developed into adult spasticity simulator which raise some argument, and no further studies have reported the progress of the work in implementing HESS into therapy education.

In a previous study, D. I. Grow et al. reported the development of a child spastic arm simulator [25]. To ensure the clinicians receive good experience with force feedback to control the movements of the patient's arm, a haptic device was created with the design of a child's spastic elbow. It used a brake actuator and a high-resolution optical encoder. The spastic arm simulator of a child was built based on a simulated trajectory without clinical data reference and tested and validated by an expert physical therapist. The results showed that one of the simulated models was more realistic with a variety of reflex velocities. Though the researcher made plans to conduct two more experiments in the future, further studies have not been reported since 2008.

Tetsuya Mouri et al. has developed a robot hand for therapist education purposes [17] [26]. It was able to generate a torque based on patient contracture condition with a 5-fingered hand driven by a servomotor. Resembling a human hand, the joint allowed palmar flexion and dorsiflexion. A small and light-weight control system was constructed for the robot hand and it was covered by an artificial skin glove to make the robot hand feel more realistic. The system of the robot hand consisted of a hand control system and a measurement system for the distributed tactile sensor. The prototype was then evaluated by a therapist in order to evaluate the efficiency of the robot hand. As a result, the therapist expressed doubt regarding the range of movements. The researchers further planned to allow therapists to evaluate the rehabilitation robot hand for practical purposes, however later reports states that the robot hand has been applied into humanoid robot research purpose instead of for therapy education.

Table 1 Comparison between four researches conducted on upper limb patient simulator

	Upper Limb Patient Simulator	HESS	Haptic Simulation Elbow Joint	Robot Hand
References	[21-23]	[4, 24]	[25]	[17, 26]
Research Centre	Research Organization for Advance Engineering, Shibaura Institute of Technology, Japan	National Institutes of Health, Clinical Center, Rehabilitation Medicine Department, Bethesda, MD 20892 USA	Department of Mechanical Eng, Laboratory for Computational Sensing and Robotics, The Johns Hopkins University	Gifu University, Gifu, Japan
Authors	Y. Takahashi, T. Komeda, H. Koyama, S. I. Yamamoto, T. Arimatsu, Y. Kawakami, and K. Inoue	Hyung-Soon Park, Jonghyun Kim, Diane L. Damiano	D. I. Grow, M. Wu, M. J. Locastro, S. K. Arora, A. J. Bastian, A. M. Okamura	Tetsuya Mouri, Haruhisa Kawasaki, Yutaka Nishimoto, Takaaki Aoki, Yasuhiko Ishigure, Makoto Tanahashi
Last Publication	2012	2012	2008	2008
Target Symptoms	Spasticity & Rigidity	Spasticity	Spasticity	Contracture
Level of Disease	Mild Moderate Severe	4 (MAS 1, 1+, 2, and 3)	None	None
Clinical Data	Simulated patients data - 1 therapist	Data from 4 paediatric patients	None	Simulated patients data - 3 therapists
Model Simulator Size	Adult	Adult	Child	Adult (greater than human hand)

Actuator	<ul style="list-style-type: none"> • Magneto Rheological Brake (slow particle settling rate) • (need to be supported by) DC Servo Motor • Harmonic drive (to reduce backlash) 	<ul style="list-style-type: none"> • Brushless DC Motor (fast responses) • Cable driven speed reduction mechanism (small friction, near zero backlash) 	<ul style="list-style-type: none"> • DC brushed motor • Disc brake 	<ul style="list-style-type: none"> • ServoMotor
Sensor	Strain Gauge	Torque Sensor	None	Distributed Tactile Sensor
Arm Structure	<ul style="list-style-type: none"> • Build with humerus, ulna and radius bones • Flexion/Extension Movement • Pronation/Supination Movement • Wrist extension movement • Covered with prosthetic silicon glove 	<ul style="list-style-type: none"> • Build with mannequin forearm; no elbow • Flexion/Extension Movement • Fixed position 	<ul style="list-style-type: none"> • Build with aluminium plate forearm • Covered with prosthetic silicon glove 	<ul style="list-style-type: none"> • Build with forearm and 5 fingers • 2 DoF pronation/supination and palmar flexion/dorsiflexion • Each finger has 3 joints- MP, PIP, DIP • Covered with artificial skin glove

Prototype

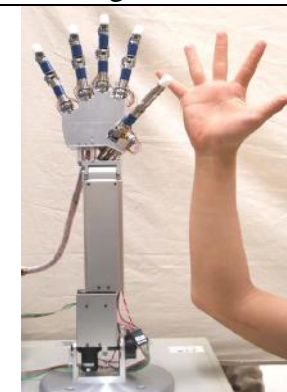
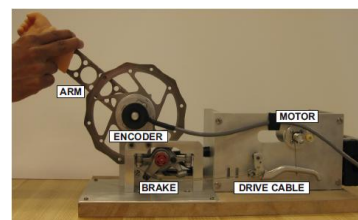
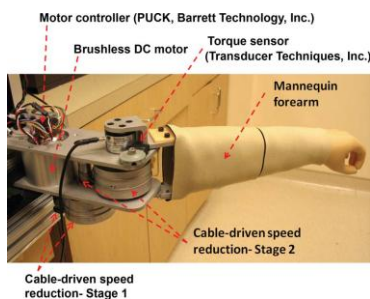
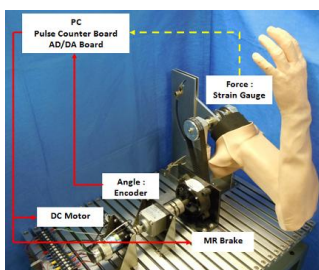

Evaluators	1 occupational therapist	3 raters (reducing inter-raters variability)	1 physical therapist	2 therapists
Evaluation Summary	<ol style="list-style-type: none"> 1. The research focused on the training device with good haptic feedback system. 2. However the system did not use clinical data as the reference to simulate upper limb disorder. 3. The research is still ongoing, with further improvement by other principal researchers under the same institute. 	<ol style="list-style-type: none"> 1. Clinical data collection 2. Clinical mathematical modelling 3. System integration 4. Clinical evaluation 5. Poor to moderate inter-rater reliability during evaluation 	<ol style="list-style-type: none"> 1. The research did not focus on the training device. Related to research focusing on modelling haptic feedback 2. The system used a brake torque 3. Very minimal information on the system 4. Future experiments to be conducted, but no new publications have been found 	<ol style="list-style-type: none"> 1. Evaluation using 1 - 5 grades, 10 items (refer Table 4) 2. Torque response was not quick, but followed desired value

2.3 Design Methodology for Medical Training Devices

Based on the 1976 Medical Device Amendments, the US Food and Drugs Administration (FDA) classifies three categories of medical devices based on the risks associated. On the contrary, medical devices manufactured, imported or sold in Japan, codes and generic names are set and classified as Class I, II, III, and IV by the Japanese Medical Device Nomenclature (JMDN). From the description listed in Table 2, patient simulator and part-task trainer can be considered under medical devices Class II: requiring regulatory controls on the effectiveness and posing low potential risks to human life and health in the event of a malfunction.

With relation to the medical devices classification, FDA has provided a design control regulation for medical devices as outlined in Section 820.30 of 21 CFR 820 [27]. Manufacturers of medical devices in Class II and III and certain devices in Class I are required to follow the regulations. The design control is based on the 'verification' and 'validation', or 'V&V' [28]. 'V&V' is a conventional approach in developing any product, where its core principle is to compare design output with the design input. However, solving the design input does not prove that we have solved the right problem, if the design process started with a wrong questions. This often happened in the medical field, where only one side of the user's needs are taken into account, while others are neglected.

The value-driven design philosophy proposed by the American Institute of Aeronautics and Astronautics (AIAA) [29] helped balance the needs of the different stakeholders that held different perspectives when it comes to evaluating 'good' technologies. The conceptual framework was further described by Benjamin D. Lee et al (2014) in [30]. The Front End Product Development Process for medical device innovation [31] has been developed based on the value-driven design which recognised different

areas/levels of the stakeholders. A combination of a few design methodologies must be considered when developing a complete design control system for medical devices, specifically for those that require different research fields, apart from the medical and engineering fields alone. A concrete design model, beginning from finding the right problem question to suitable design methods and a complete validation system, is very much needed.

Table 2 Classifications of medical devices according to US and Japan regulations

Device Classification	US Department of Health and Human Services [32]	Japan Ministry of Health, Labour and Welfare (MHLW) [33]
Class I	Class I devices are deemed to be of low risk and are therefore subject to the least regulatory controls. For example, dental floss is classified as Class I device.	Poses an almost insignificant risk to human life and health in the event of malfunction or side effects. Although they do not require approval, notification must be submitted to PMDA, and the requirements outlined below must be met.
Class II	Devices that pose higher risk than Class I and require greater regulatory controls to provide reasonable assurance of the device's safety and effectiveness. For example, condoms are classified as Class II devices	Controlled medical devices/designated controlled medical devices (Class II) are those other than specially controlled medical devices deemed by MHLW to require management in relation to the relatively low potential risk they pose to human

life and health in the event of malfunction or side effects.

Class III & Class IV	<p>Class III devices are generally the highest risk devices and are therefore subject to the highest level of regulatory control. Class III devices must typically be approved by FDA before they are marketed. For example, replacement heart valves are classified as Class III devices.</p>	<p>Specially controlled medical devices (Class III & IV) are those deemed by MHLW to require appropriate management in relation to the relatively high or potentially fatal risk they pose to human life and health in the event of malfunction or side effects.</p>
----------------------	--	--

PMDA: Pharmaceutical and Medical Devices

2.4 Articulation of Upper Limb

The upper limb is made up of three parts to define its structure. They are the upper arm, the forearm, and the hand. The upper arm consists of the humerus bone, while the forearm consists of two bones: the ulna bone, which is located on the lateral side of the forearm and the radius bone, which is located on the medial site of the forearm, running almost parallel to the ulna. The bone structures of the upper and the forearm are connected via the elbow joint, and this joint can be subdivided into three, consisting of the humeroulnar joint, the radiohumeral joint, and the proximal radioulnar joint. The first and second joints are a hinge-joint that only allow flexion and extension. The proximal radioulnar joint allows the supination and pronation of the forearm around the elbow joint. When supinating the forearm, the radius rotates with the thumb-side of the hand around the ulna. Likewise, pronation involves the reverse rotation of the radius around the ulna.

(Figure 2 - (Donald A. Neumann. *Kinesiology of the Musculoskeletal System – Foundation for Physical Rehabilitation*. Mosby, Inc. 2002 [34]). The ulna bone is shorter than the radius, which means only the base of the radius connects to the wrist joint of the hand.

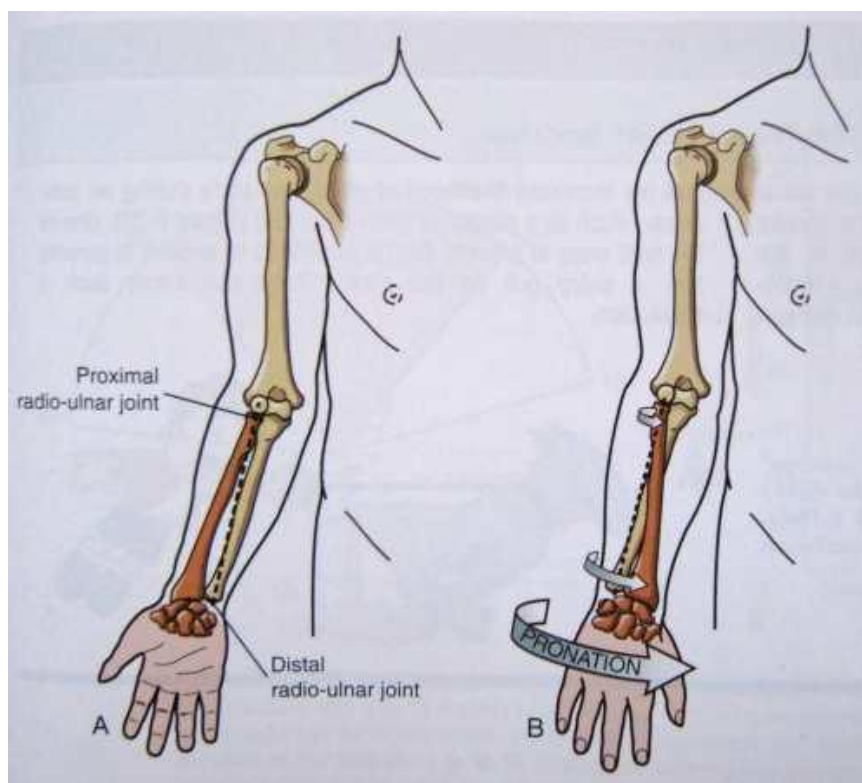

Figure 2 Illustration of pronation around fixed humerus (Donald A. Neumann. *Kinesiology of the Musculoskeletal System – Foundation for Physical Rehabilitation*. Mosby, Inc. 2002 [34])

2.5 Spasticity

Spasticity is one of the upper motor neuron syndrome (UMNS) that interferes with basic motor tasks, which is required to accomplish daily activities. The definition of spasticity was put forth by Lance (1980) as: “a motor disorder characterised by a velocity dependent increase in tonic stretch reflexes (muscle tone) with exaggerated tendon jerks, resulting from hyper-excitability of the stretch reflexes, as one component of the upper motor neuron syndrome”. When passive force is applied to the muscle, stretching the

muscle inappropriately increases muscle tension and gives resistance to passive motion. Cerebral palsy and stroke are two common conditions that exhibit spasticity. According to the National Stroke Association of Malaysia (NASAM), stroke is the third largest cause of death in Malaysia [35]. Cerebral palsy, on the other hand, is the most common congenital disorder of childhood.

Stroke is one of the greater health problems that affect the human daily routine worldwide [36]. According to the latest data from WHO (in May 2014), stroke deaths in Japan has reached 13.12% in total and currently the number one cause of death in the country [37]. Meanwhile, in Malaysia, the total death caused by stroke has reached 12.19%, or 15,497 deaths, coming in second after the coronary heart disease, which is 23.10% of overall the Malaysian population [38].

It is a syndrome resulting from different impairments, such as primary cerebral ischemia and cerebral haemorrhage, which cause a sudden onset of the disruption of blood supply to the brain [39]. As a result, the brain cells will not function normally. As stroke causes great disability, it is classified as a medical emergency that may cause permanent neurological damage, or worse, leading to death [36]. Spasticity is one of the later signs of stroke [40]. Damage to the central nervous system may cause UMN Syndrome, with an increasing risk of developing spasticity [41]. Because it is crucial to promote the recovery of lost function, independence, and early re-integration into social and domestic life, patients with spasticity require continuous treatment to train their muscles and recall basic movements. This process of training and re-learning is termed as rehabilitation.

Upper limb rehabilitation is an integral part of post-stroke therapy to ensure the arm regains its maximum functions. Therefore, the therapist will apply repetitive arm training for the patient until the brain gradually records the repeated movement [42]. This technique helps the brain regain normal movements at both of the affected and unaffected

sides [41]. During early post-stroke rehabilitation, therapy sessions may be one-to-one between the patient and the therapist.

2.6 Modified Ashworth Scale for Spasticity Assessment

A few approaches are used for clinical assessment in spasticity [43]. Two of the more commonly used methods in estimating spasticity levels are the Ashworth Scale (AS) and the Modified Ashworth Scale (MAS) [2] Table 3). Both methods do not require any additional devices to perform the tests. Several studies have been conducted to evaluate the reliability of MAS and they concluded that it is a reliable marker to test upper limb spasticity in comparison to lower limb spasticity [1, 44]. Furthermore, MAS has proven that it can provide better inter-rater reliability for the assessment of children with cerebral palsy [45].

These assessments are used by physicians, occupational therapists, and physical therapists to assess the severity level of spasticity [46, 47]. To obtain the skills to evaluate spasticity level using MAS, current practice in the training of students utilizes patients as primary learning subjects, other than role-play training and Standardised Patient actor. Because these vary depending on the institution and the number of patients engaged, they have resulted in a variability in rater scores. Therefore, it is essential for the raters or the therapists to have sufficient professional experience when working with these standardised methods [3].

Table 3 Comparison between Ashworth Scale and Modified Ashworth Scale Assessment

Ashworth Scale	Score	Modified Ashworth Scale
No increase in muscle tone	0	No increase in muscle tone
Slight increase in muscle tone, giving a 'catch' when the limb is moved in flexion or extension	1	Slight increase in muscle tone, manifested by a catch and release or by minimal resistance at the end of motion, when the affected part(s) is moved in flexion or extension
-	1+	Slight increase in muscle tone, manifested by a catch, followed by minimal resistance throughout the remainder (less than half) of the Range Of Motion
More marked increase in muscle tone, but limb is easily flexed	2	More marked increase in muscle tone through most of the Range Of Motion, but the affected part(s) is easily moved
Considerable increase in muscle tone - passive movement difficult	3	Considerable increase in muscle tone, passive movement is difficult
Limb is rigid in flexion or extension	4	Affected part(s) is rigid in flexion or extension

This is due to other factors that contribute to the inter-/intra-raters' variability, such as the condition of the patients during the assessment (i.e. fatigue level and posture) and subjective terms in MAS, such as 'slight increase', 'more marked', and etc. to described each level. As they are interpreted differently according to each assessor, a general quantitative pattern of MAS has therefore been illustrated in Table 4 hypothetically.

'Catch' or 'resistance', as stated in the MAS assessment descriptions, can be represented with sudden increment in moment [N.m] with accordance to the forearm angle movement and angular velocity. 'Catch position' is an important item in assessing spasticity, as it defines the level of severity. The 'catch position' detected during the first half of the Range Of Motion (ROM) shows patients with a severity MAS score of 0 to 1+,

while the 'catch position' that occurs during the remainder half of ROM shows patients with a level more than MAS 2.

Table 4 *Illustration of general pattern of Modified Ashworth Scale (MAS) in quantitative hypothesis*

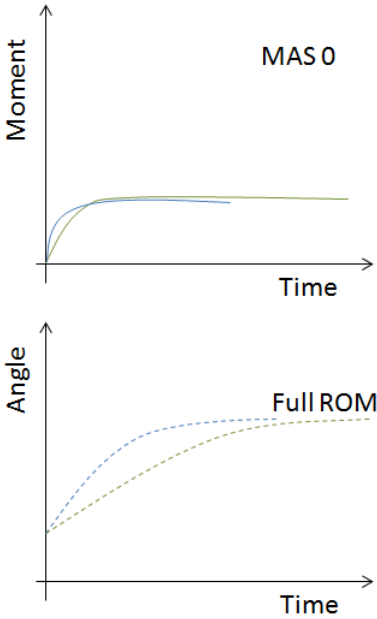
Score	Modified Ashworth Scale	General Pattern
0	No increase in muscle tone	 <p>The figure contains two vertically stacked line graphs. The top graph has 'Moment' on the vertical axis and 'Time' on the horizontal axis. It shows a curve that starts at the origin, rises steeply, and then levels off to a horizontal line. The label 'MAS 0' is placed in the upper right area of this graph. The bottom graph has 'Angle' on the vertical axis and 'Time' on the horizontal axis. It shows a curve that starts at a positive value on the vertical axis, rises, and then levels off. A dashed line indicates the final level, which is labeled 'Full ROM'.</p>

- 1** Slight increase in muscle tone, manifested by a catch and release or by minimal resistance at the end of motion when the affected part(s) is moved in flexion or extension

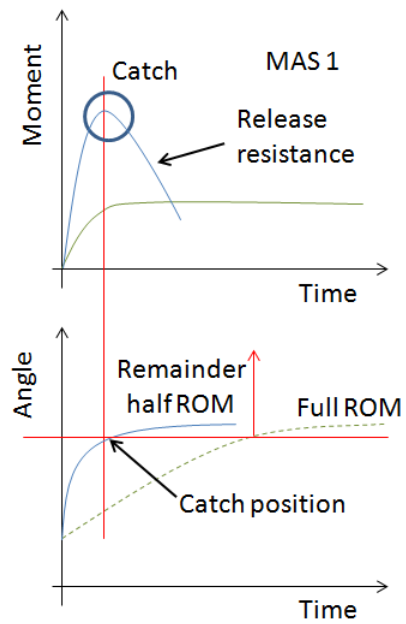

- 1+** Slight increase in muscle tone, manifested by a catch, followed by minimal resistance throughout the remainder (less than half) of the Range Of Motion

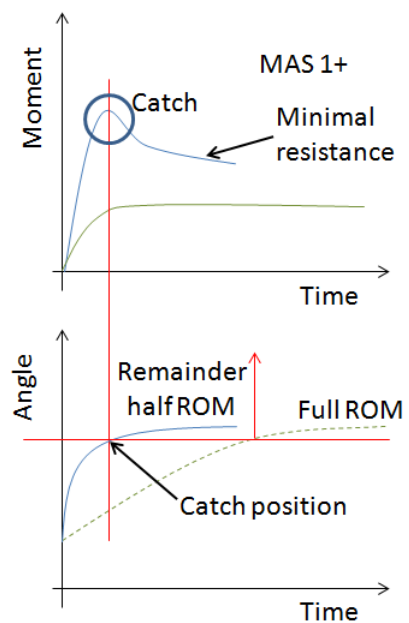

2

More marked increase in muscle tone through most of the Range Of Motion, but the affected part(s) is easily moved

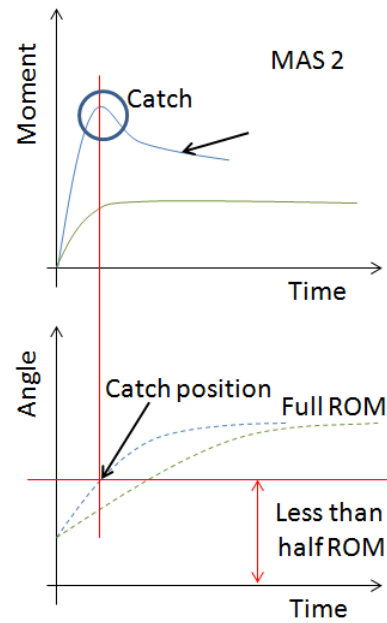

3

Considerable increase in muscle tone; passive movement is difficult

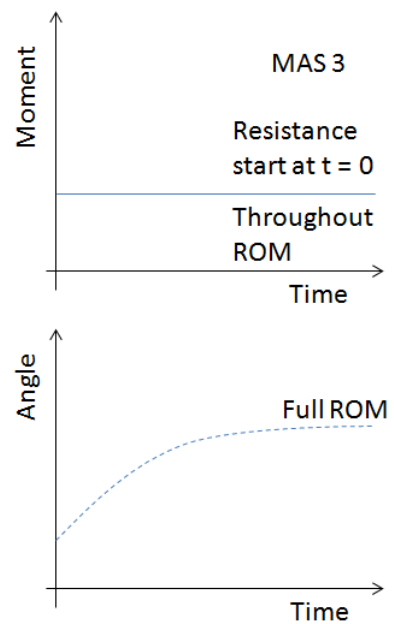

- 4 Affected part(s) is rigid in flexion or extension

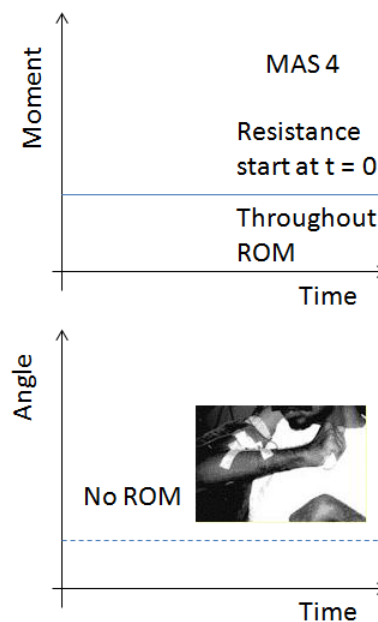

----- Fast stretch - - - - - Slow stretch

2.7 Modified Tardieu Scale for Spasticity Assessment

Other than the AS and the MAS, the Modified Tardieu Scale is reported to provide higher inter-rater reliability compared to the MAS for adult spasticity [48]. The Modified Tardieu Scale is used to assess the muscle feedback in response to passive stretch at different velocities, both slow and fast speeds. Two measurements are conducted: 1) quality of muscle responses and 2) Tardieu Angle. Goniometer is utilised to measure the Tardieu Angle.

The quality of muscle responses to slow and fast stretches are indicated using the scores 0 - 5 as shown in Table 5 below, while the Tardieu Angle is calculated by subtracting the angle of muscle response R1 during a fast stretch from the R2. The angle of a full Range Of Motion (ROM) is measured during slow speed stretch.

Table 5 Descriptions for Modified Tardieu Scale

Modified Tardieu Scale	
Scale	Description
0	No resistance throughout passive movement
1	Slight resistance throughout, with no clear catch at a precise angle
2	Clear catch at a precise angle, followed by release
3	Fatigable clonus (<10 sec) occurring at precise angle
4	Not fatigable clonus (>10 sec) occurring at a precise angle
5	Joint immobile

Several reliability tests were conducted previously on the MTS assessment towards cerebral palsy [49] and stroke patients [50]. With further elaboration in these matters, Mehrholz et al (2005) conducted a test-retest reliability on MTS for severe brain injury and found that it had an adequate intra-rater reliability with $k = 0.65-0.87$ for the tested group [48]. Paulis et al (2011) found that Tardieu Scale showed excellent correlation (R2-R1, goniometric 0.86) when performed with goniometer in the test-retest reliability of stroke patients with elbow flexors [51].

CHAPTER 3

METHODOLOGY

3.1 Research Framework

The Front End Product Development Process for medical devices has been taken into consideration when designing our research framework for medical training device. Figure 3 shows the illustrated Front End Product Development Process, where various stakeholders connect at different levels of the upper limb spasticity part-task trainer's innovation process. The different perspectives of the stakeholders guided the developing team towards achieving an important value in the part-task trainer development without focusing on specific attributes, which will only limit the product design space.

With reference to Figure 3, stakeholders are composed of three different groups. For the development of the part-task trainer as a learning tool, the stakeholders were identified (Table 6). The voices of novice therapists, physicians, and patients are considered as the Voice of Customers (VoC), supported by the education institution, the regulatory bodies (i.e., World Federation of Occupational Therapists-WFOT, World Confederation for Physical Therapy-WCPT), and medical device companies who work as

the representatives of the Voice of Business (VoB). These voices will then be combined with the current technology suggested by the Voice of Technology (VoT), the Research and Development team, and manufacturing vendors as well.

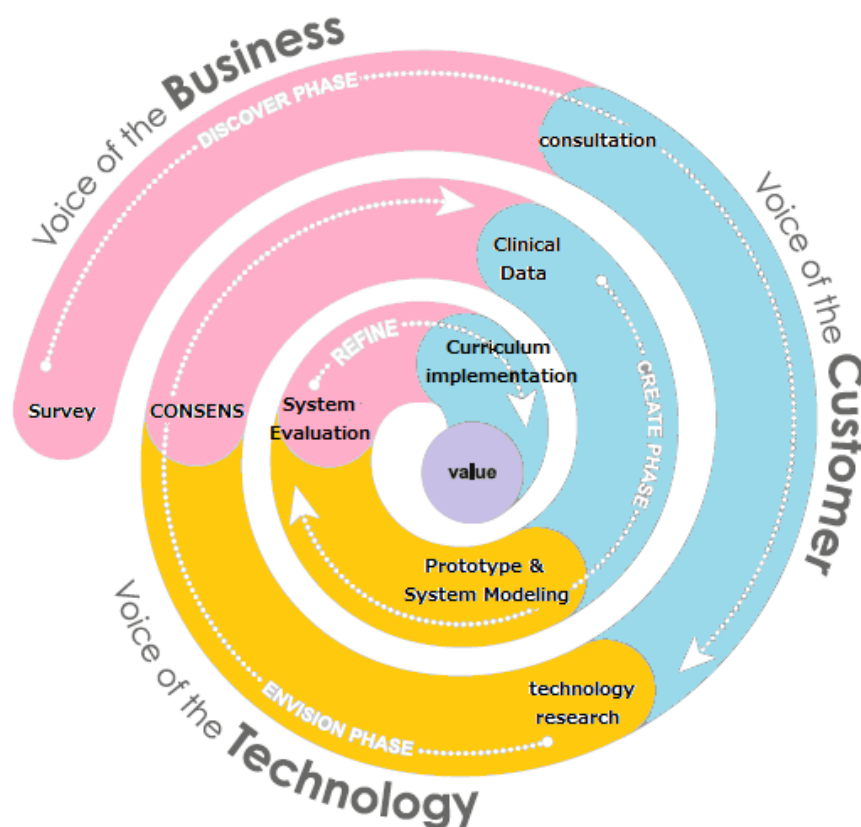

Figure 3 Illustration of Front End Product Development Process for upper limb spasticity part-task trainer

Table 6 List of identified stakeholders

Voice of Customer	Voice of Business	Voice of Technology
Novice Therapists	Education Institution	R&D Team
Physicians, Therapists, Educators	Regulatory Bodies	Vendors
Patients	Government	

Our research team consisted of a rehabilitation physician, as well as a therapist; both are specialists in their respective fields and give lectures to novice therapists at the same time. They represented the Voice of Customers, giving knowledge and ideas based on their related perspectives. The engineers from mechanical engineering, software engineering, and bioscience engineering worked as the R&D team, along with the vendors, in accomplishing the required prototype. With the Voice of Business, ethics approval was obtained from the Research Ethics Committee of Universiti Teknologi MARA and the National Medical Research Register Malaysia.

3.2 Research Method

The development process was divided into four phases as shown in Figure 4.

Discovery Phase: In this phase, it is important to extract the right information to form the basis of the research. We started by interviewing our collaborators, i.e. a therapist educator from the Division of Occupational Therapist at the Tokyo Metropolitan University and a rehabilitation physician from the Faculty of Medicine at Universiti Teknologi MARA. Both educators were interviewed to acquire their opinions regarding the current therapist education and the additional learning tools that would help in their practice. As a result from the discussions, we decided to conduct a questionnaire-based survey [5] to collect opinions from the therapists and their institutions randomly regarding the current therapy education and their opinions concerning the part-task trainer as a learning tool. At the same time, the R&D Team conducted a literature review on the current technology related to the part-task trainer as a learning tool. From time to time, the engineering team consulted with the rehabilitation physician and therapist educator concerning the current practices in therapy education, as well as the methods to quantify the characteristics of upper limb disorders.

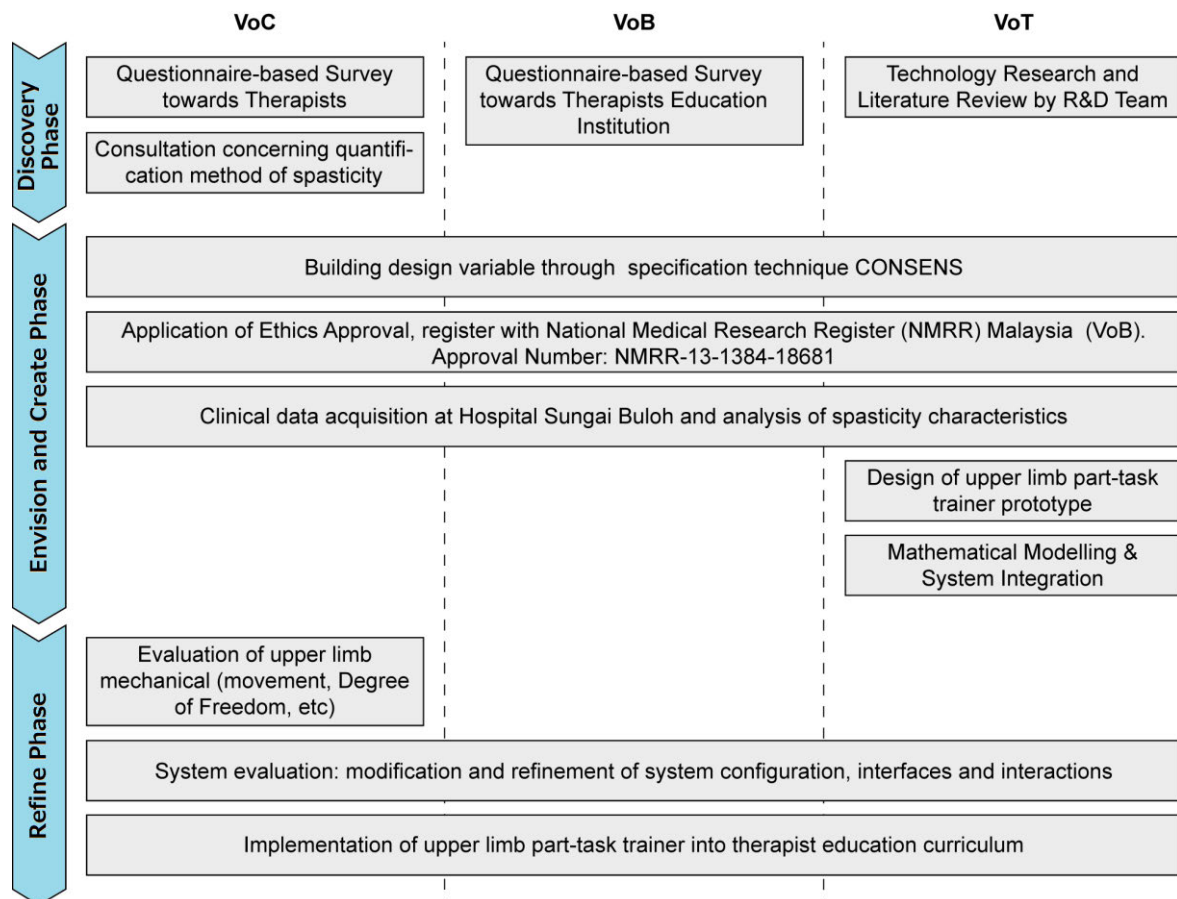

Figure 4 Research activities based on the stakeholders' voices throughout the design process

Envision Phase: The envision phase discussed the direction of the project. This included the application of the specification technique CONSENSTM introduced by [52, 53] to define the design specification. The upper limb part-task trainer as a learning tool was developed previously in [21] before considering the various stakeholders' voices. Thus, in this phase, it was decided that the objectives would be improved by applying other specification details. The specification technique CONSENSTM illustrated in Figure 5 provides a basic concept that can be shared with the related stakeholders in each level. The clinical database collection was supported by the Voice of Business in order to emulate continuously and loosen the stiffness of the spasticity symptoms as needed by the Voice of Customer. The overall part-task trainer hardware and software development was completed by the R&D team from the Voice of Technology.

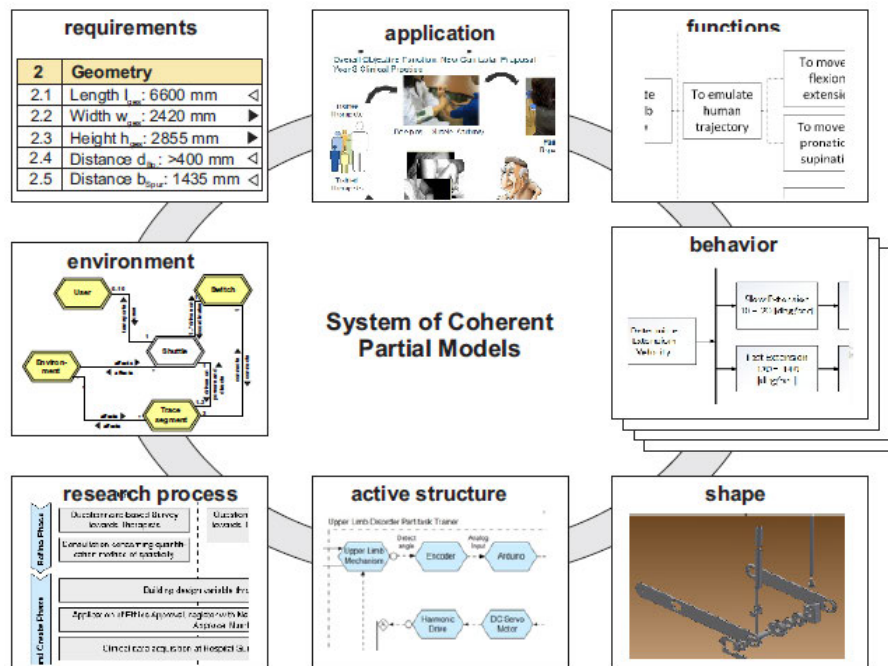

Figure 5 Partial model for the domain-spanning description based on the specification technique CONSENS™

Create Phase: In this phase, the previous prototype was improved upon by referring to the information from the specification technique CONSENS™. With the purpose of improving the part-task trainer, a set of clinical data is necessary to develop a mathematical modelling describing the characteristics of the spasticity disorder. The ethics approval was given by the Ethics Committee of Universiti Teknologi MARA and the project was registered with the National Medical Research Register (NMRR) Malaysia. (Approval number: NMRR-13- 1384-18681). Clinical Data Collection was conducted in Sungai Buloh Hospital [54]. From the clinical data acquisition, the behaviour of the system could be designed and the development of the control system could be completed. The creation phase ended with the systems integration between the mechanical prototype and dynamics movement control.

Refine Phase: In this phase, two parallel evaluations were conducted. The evaluations were done on the upper limb mechanical movement (i.e., elbow joint, degree of freedom) and a systems evaluation (i.e., spasticity muscle stretch reflex). To validate the concept of applying the part-task trainer as a learning tool to increase training frequency, the evaluation shall be conducted by a physician and licensed therapists, some of whom included novice therapists from one of the therapist education centres. Once the prototype was validated, a marketing team was established to conduct an assessment survey on the education centres that prescribed the part-task trainer in their curriculum.

Each listed research activities were conducted throughout the design process. Details of research activities were described separately in the later chapters respectively.

CHAPTER 4

QUESTIONNAIRE-BASED SURVEY

4.1 Survey Method

In this chapter, the method to conduct a questionnaire-based survey on the therapists is discussed. The objectives of this questionnaire-based survey is to understand the needs and the necessity of this upper limb part-task trainer development project.

It is known that assessing spasticity using the Modified Ashworth Scale (MAS) and Modified Tardieu Scale (MTS) have led to inter-raters and intra-raters variability, due to the lack of standardization for the number of repetitions, testing time (morning/afternoon), test positions [1], etc. for the respective scales. Other factors that contribute to the inter-raters and intra-raters variability include the fluctuating forearm extension speed for spasticity raters [6]. Despite the limitations of the MAS assessment method, it is still used widely for evaluation in clinical and educational settings.

As a solution, a robotics system with the ability to simulate patients' conditions have been developed as a training tool for rehabilitation and clinician training. However, there is a paucity in the implementation of this training tool, so as to identify whether it

will be accepted in the clinical field and rehabilitation education centres, and how the learning tool will be applied in education modules.

Therefore, a set of questionnaires as shown in Table 7 were randomly distributed to physiotherapists and occupational therapists. The survey, which was conducted in both the Japanese and English languages, consisted of ten questions with multiple-responses, ranging from *strongly disagree* - *disagree* - *agree* - *strongly agree* according to given statements. The survey also included extended-response questions and suggestions from previous statements given in the questionnaire.

Table 7 List of questions provided in the questionnaire-survey

No.	Questions
Section A: Current Therapy Education	
1	Current education of physiotherapists and occupational therapist training is applying low fidelity mannequins, role-play training between students or faculty physician and simulated patients. Current training method (might differ in different countries) is enough before the students engage with real patients during their clinical training.
2	Using method of low fidelity mannequins, role-play training between students or faculty physician and simulated patients, the students will risk the patients' safety during their clinical training.
3	Despite the use of current methods such as low fidelity mannequins, role-play training between students or faculty physician and simulated patients, we still have variable ratings of patients' symptoms severity between the therapists and within the therapist himself/herself.
4	Students require higher frequency of training before engaging with real patients during their clinical training.
Section B: Training Simulator	
5	Based on the explanation above, the suggested education method and the patient simulator application can be implemented during physiotherapist and occupational therapist training.

- 6 I am interested in applying the suggested education method and patient simulator in my department/university.
Give your comment on your answer in Question 6.
- 7 With the implementation of a patient simulator, the new training method could provide higher frequency of training for the students.
- 8 With the implementation of the suggested education method and the application of patient simulator into physiotherapist and occupational therapist training, we can increase patient safety during clinical training.
- 9 With the implementation of the suggested education method and the application of patient simulator, we can increase the therapists' rating ability and reduce the ratings variability.
- 10 Suggestion towards improving the training simulator described in the questionnaire.

The questionnaire was divided into two sections, namely **Section A**: Current Therapy Education and **Section B**: Training Simulator. The questions in Section B concerned the part-task trainer that was developed in our laboratory (APPENDIX A).

4.2 Survey Results

From the conducted survey, a total of 22 physiotherapists and occupational therapists, who are involved in the clinical education fields from Malaysia and Japan, participated in this study.

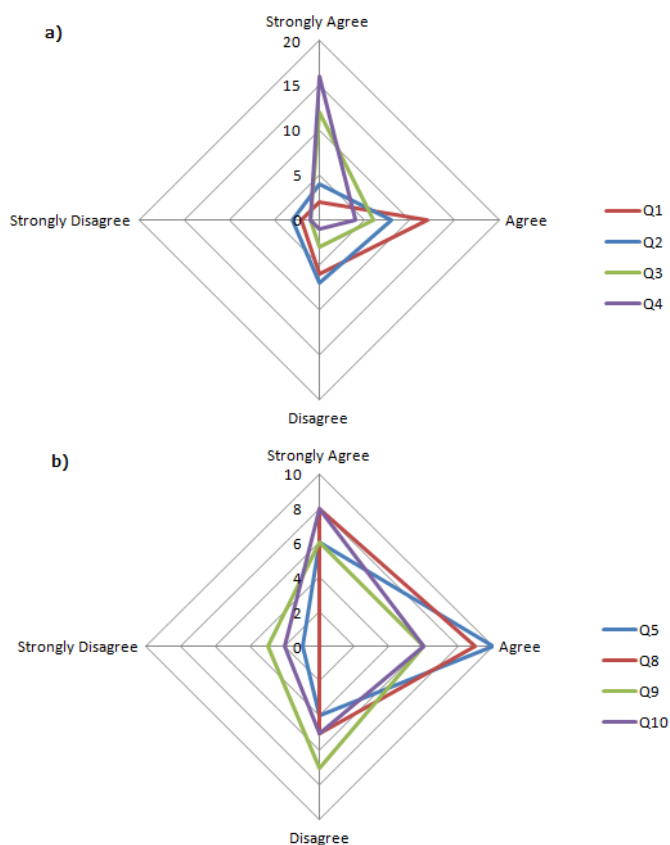

Figure 6 (a) *Therapists' responses towards questions in Section A: Current Therapy Education*, (b) *Therapists' responses towards questions in Section B: Training Simulator*

4.2.1 Therapists' Response towards Current Therapy Education

Based on the results shown in Figure 6 (a), 81% of the therapists strongly agreed and agreed that by depending only on the current training methods to teach novice therapists, there was a high possibility in contributing to variable ratings between the raters and intra-raters themselves. 54% believed that novice therapists might risk injury to patients during their first clinical contact, while 91% of the educators supported the idea that novice therapists should have a higher frequency of training. This is unfeasible if they remained with the current education method, as they are only exposed to have role-play

practice on their friends or their educators, which limited the frequency of their training. When asked about the frequency of student training, 72% of the respondents strongly agreed that the students needed a higher frequency of training before they engaged with real patients during clinical rehabilitation sessions.

4.2.2 Therapists' Response towards Therapy Training Simulator

Figure 6 (b) illustrates the responses towards the development of our training simulator. 72% of the therapist educators believed that the suggested method and the part-task trainer could be implemented into the therapist's clinical training. 77% (strongly agreed and agreed) thought that the new training method could provide a higher frequency of training to students. 63% of the participants agreed that the therapist's rating ability could be increased and the ratings variability reduced.

4.2.3 Implementation of the Upper Limb Spasticity Part-task Trainer

Respondents were also asked whether they were interested in the part-task trainer. According to the results, all the respondents had never seen the described simulator prior to participating in the survey. 55% of the respondents were interested in the implementation of the part-task trainer in their workplace.

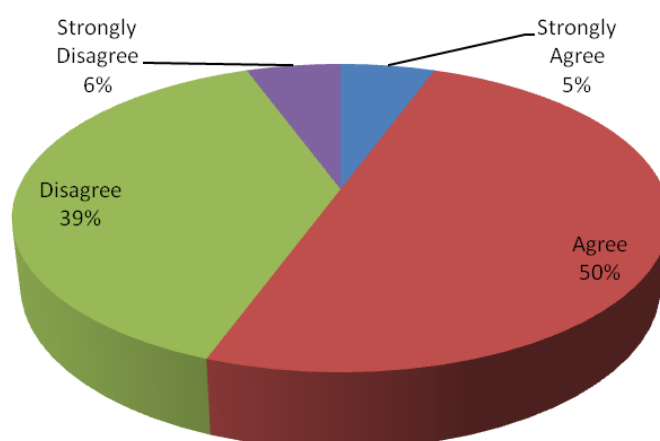

Figure 7 Therapists' response towards Question 6

4.3 Discussions

Before conducting the survey, the clinicians and therapists were concerned with the muscle and anatomy structures, while other therapists were concerned with the relation to the ethics and the manners of novice therapists if they were to train with a robot simulator instead of a human. To solve these concerns, we proposed a new curriculum and conducted a survey on it. The curriculum took into account the important lessons of anatomy and muscle during role-play and provided the chance to increase the frequency of symptoms training, with the use of the part-task trainer and practised ethics and manners with healthy old people before engaging directly with real patients during their clinical training.

In the distributed survey, the proposed new curricular was not illustrated to avoid affecting the data collection process. This may impact the respondent's responses due to its level of attractiveness. The proposed new curriculum is illustrated in Figure 8 to differentiate the focus of the curriculum into three different levels of the objectives: 1) to study human upper limb anatomy and muscle, 2) to increase the frequency of training by novice therapists with constant repetition of different levels of symptoms, and 3) to educate novice therapists on the ethics and manners towards patients through connection with healthy old people.

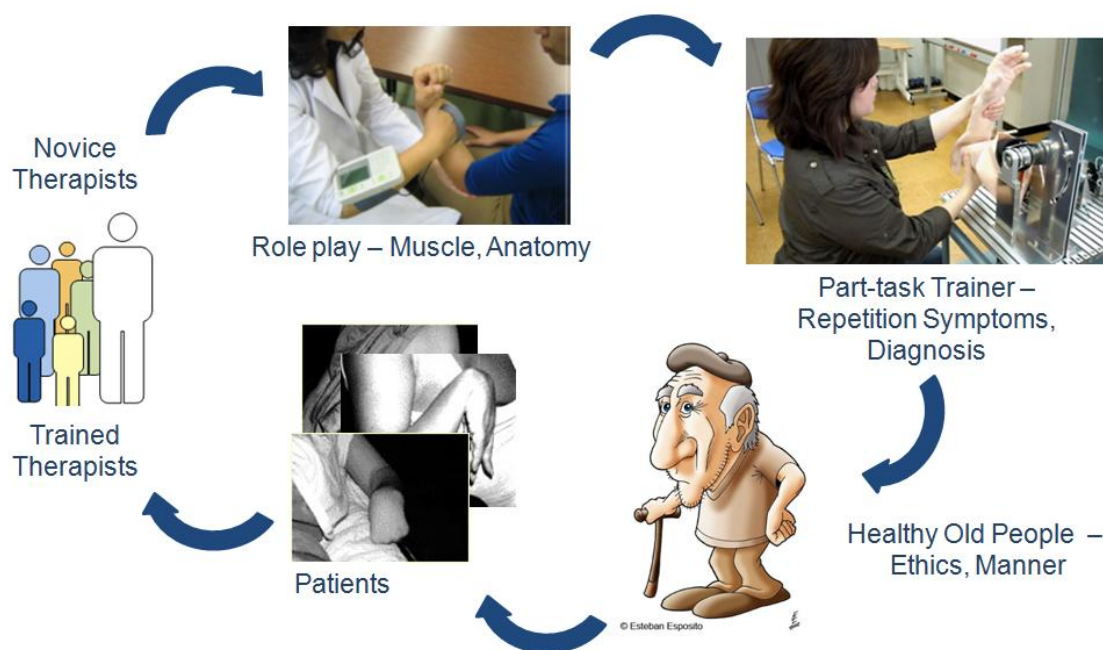

Figure 8 *Illustration of proposed new curriculum*

The questionnaire-based survey involved 22 physiotherapists and occupational therapists from the education field, with ages ranging from 26 to 57 years old (refer to Table 8). This was the first of its type to be performed in both Japan and Malaysia regarding the current therapy education and the implementation of a new device into that education system.

Table 8 Number of participants involved in the survey based on age group

Range of Age (Years)	Number of Participants
20 - 29	5
30 - 39	8
Above 40	5
Unknown	4

In this study, the therapists found that by depending on the current training methods to teach therapy trainees, there was a high possibility of contribution to the variable ratings between raters and intra-raters. The suggested education method of the upper limb spasticity simulator patient increases the possibility of higher frequency training, which should lead to a better understanding of the accompanying signs, thus improving rating levels.

CHAPTER 5

CONSENS™ PRINCIPLE SOLUTION

5.1 Model-Based System Engineering

With regards to the results from the previous survey conducted, we can wrap up that it was obligatory to provide a platform for a new trend in current therapy education, regarding the necessity to provide higher frequency of training with new technologies. To develop a medical training device, a research team with interdisciplinary background, shall be established and a systematic basis design process will be an essential core before proceeding further.

Therefore a cross-domain system model is necessary, which combines all the essential aspects of medical, engineering and education. Therefore, we developed a semi-formal specification technique that requires effective and continuous cooperation and communication between developers from different disciplines during the whole development process, especially in the early design phase (conceptual design). The benefit of a semi-formal description is the exhaustion of creativity of the developers at the beginning of a new product development. Later on, the prepared models have to be

formalised in order to carry out the initial analysis, e.g. of the logical or dynamic behaviours. To establish all these requirements of continuous model-based system engineering, a specification technique called “CONceptual design Specification technique for the ENgineering of complex Systems” abbreviated as CONSENSTM was implemented to describe the principle solution of advanced mechatronic systems. The Front End Product Development of Value Driven Design research process is combined with the CONSENSTM specification technique. Description for each partial model; **Functions, Behaviour-States, Behaviour-Activities, Active Structures** and **Shapes** is illustrated in Figure 9 and the descriptions for upper limb spasticity part-task trainer were later exemplified respectively.

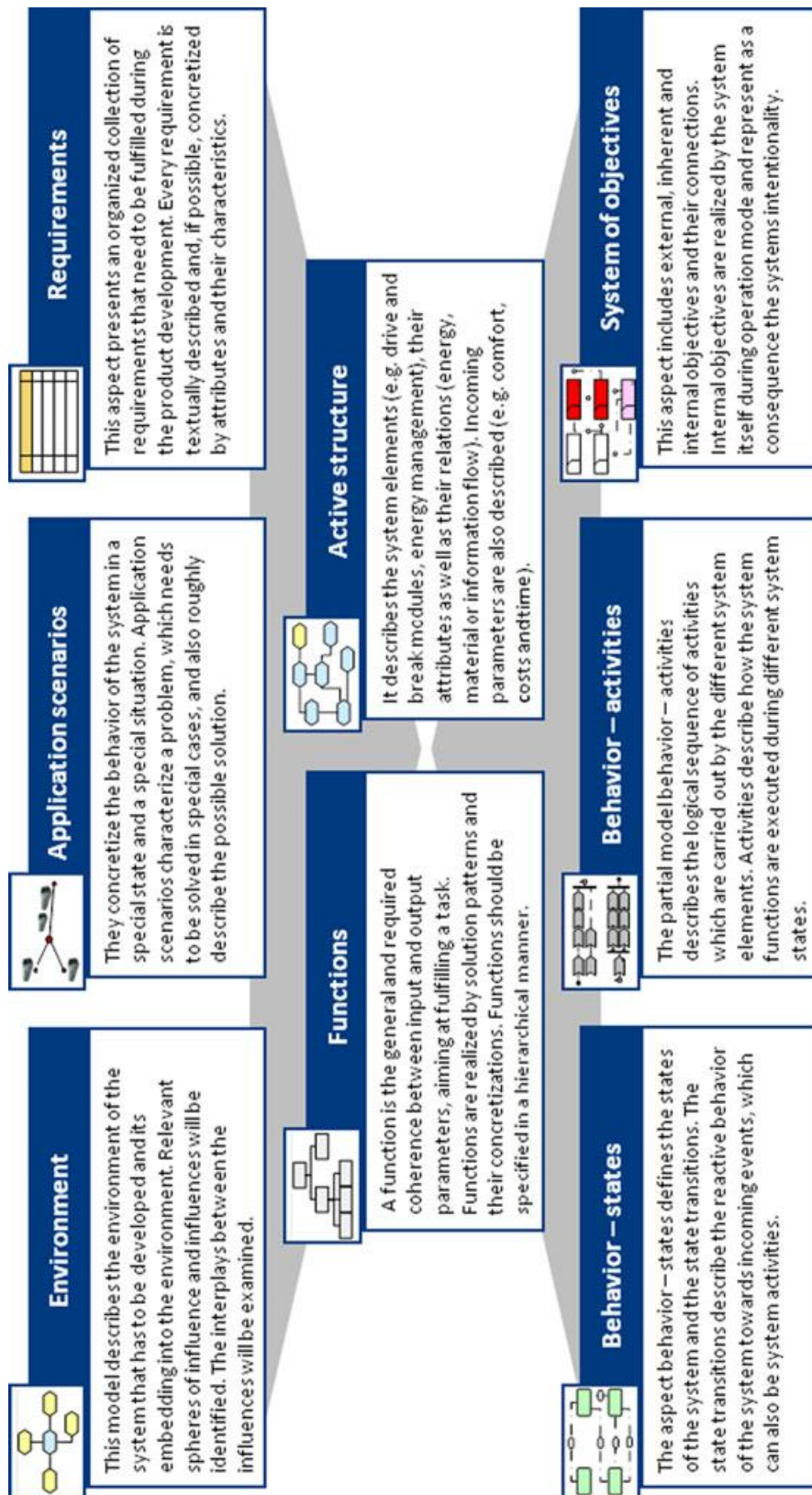

Figure 9 Partial models for the domain-spanning description of the principle solution of advanced mechatronic systems

Functions:

Figure 10 shows the functions of upper limb spasticity part-task trainer. The main functions are segregated into three function cut-outs; the ability to accurately simulate spasticity symptoms, ability to emulate the human arm trajectory and to provide human-like characteristics. To simulate spasticity stiffness, the part-task trainer must be able to detect forearm extension angle, calculate the angular velocity as the spasticity is a velocity-dependent symptom, and provide spasticity stiffness based on the calculated angular velocity and angle. Additionally, the part-task trainer needs to be able to emulate human arm trajectory in flexion/extension and pronation/supination, as well as to avoid incongruity. The part-task trainer shall have human-like arm and also able to imitate human skin softness. One of the details of the function cut-outs has been published in [55].

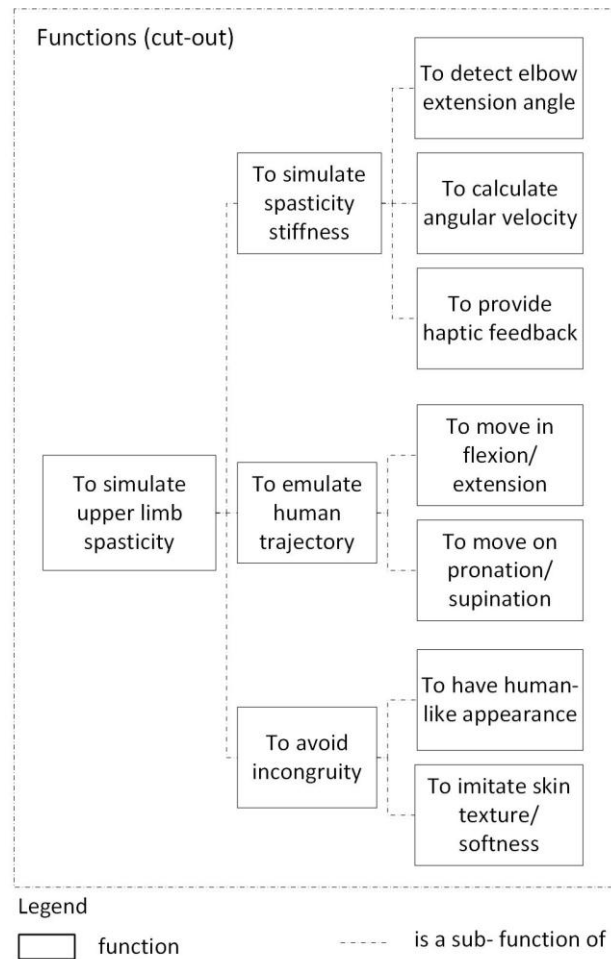

Figure 10 *Functions of upper limb spasticity part-task trainer*

Behaviour states:

Referring to Figure 11, the behaviour of upper limb part-task trainer shall be based on the clinical database. When the part-task trainer detect event E1: Angular velocity $> \omega_c$, the state is change to fast extension state. Similarly with the event E2 where the angular velocity detects value less than ω_c , the part-task trainer is translated into slow extension state and transferred into constant rigid movement. ω_c which it represents angular velocity when the muscle catch occur, based on the clinical data. The input inserted during fast extension states and slow extension states are based on the torque T_c and muscle catch angle θ_c from the database.

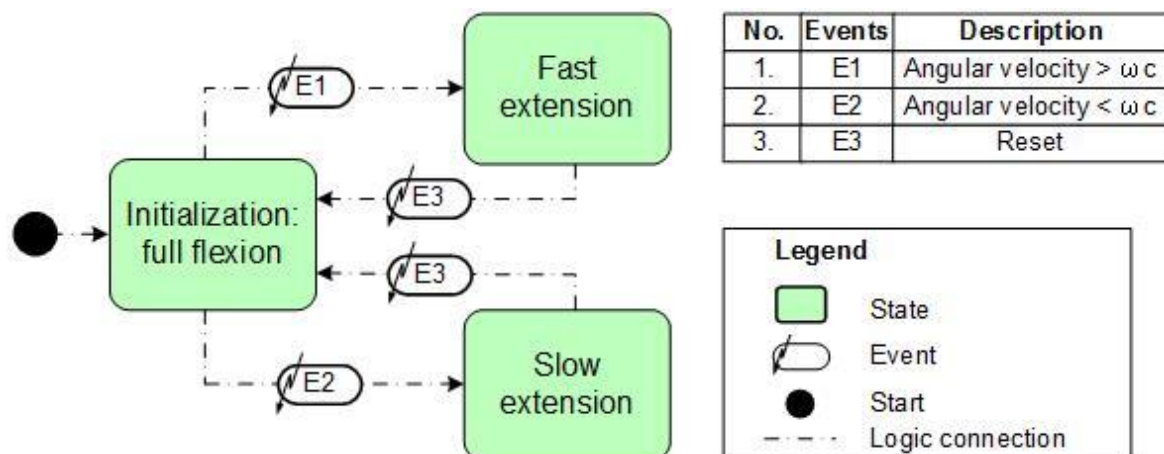

Figure 11 Behaviour states for upper limb spasticity part-task trainer

Behaviour Activities:

Figure 12 illustrates the activities of the upper limb spasticity part-task trainer. As the therapists manipulate the part-task trainer's forearm, the system will start to calculate the forearm's angle and later compute the real-time angular velocity. From the computed real-time angular velocity, the system will judge the angular velocity whether it is exceeding ω_c or less. If the angular velocity is judged as a slow extension movement, constant torque will be provided, or else, there will be an increment in the provided torque, based on the forearm angular θ_c . When the forearm angle exceeds θ_c , DC servo motor will be activated and input is generated following the difference of severity level.

Active structure:

Active structure defines a system configuration comprising of system elements and their relations as well as their attributes. Information flow and needs from the stakeholders' voices are described in the active structure illustrated in Figure 13. Prior to the physician or therapist manipulating the upper limb of the part-task trainer forearm, an encoder will detect the forearm angle input and through Arduino board; an open-sourced computer platform based on simple micro controller board theory, angular velocity is calculated thus interpreting the haptic feedback output for actuator A or B. Parameter A will activate actuator A and vice versa.

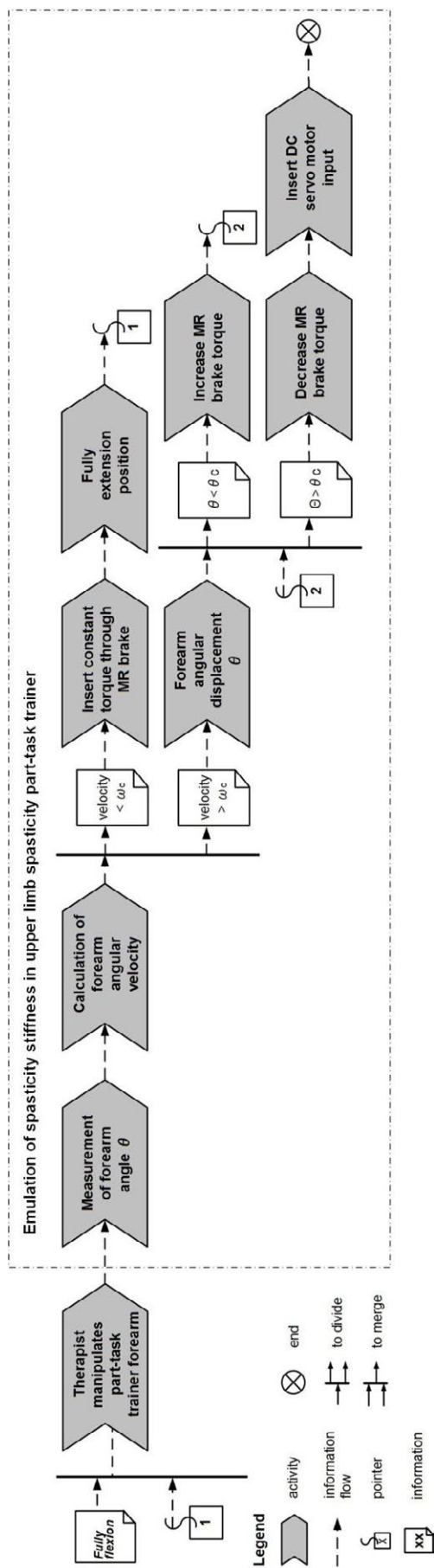

Figure 12 Behaviour activities of Upper limb spasticity part-task trainer

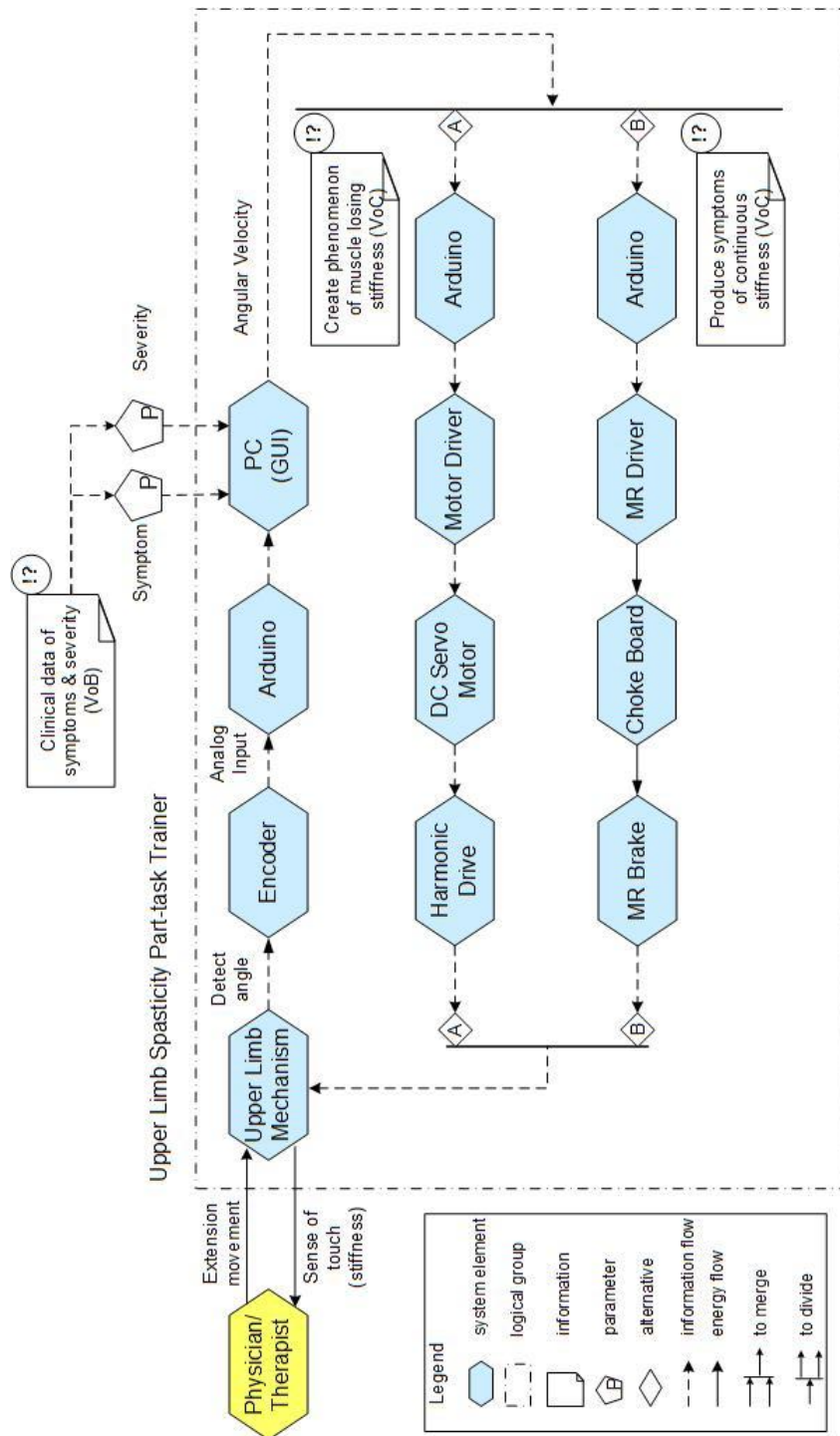

Figure 13 Specification of the active structure taking into account the stakeholder's voices

Shapes:

Prior to prototype development, a measurement was conducted to prove the effects of wrist extension caused by the extensor muscles. The objective of the measurement is to provide evidence that the length of the forearm changes in a full flexion position and a full extension position. One healthy subject was used in the measurement. The length of the subject's forearm during full flexion was measured, and the measurement of the length was recorded for different angles of the elbow joint towards the full extension position. Three trials were conducted. The results of the wrist extension tracking experiment are shown in Figure 14, where the forearm moves in an elliptic trajectory instead of a circular trajectory. The length of B is 7 mm longer than A. Based on the first prototype evaluation [23], this movement is crucial as it results in different impacts, thus enabling the therapists to get a feel for the effect of wrist extension. There are other studies as well, regarding the working space of a normal human upper limb [56] and finger motion [57].

In order to produce the ellipse movement shown in Figure 14, the elbow is built with a cam-shaped mechanical structure and the ulna bone attached to the cam follower, will move following the cam's ellipse orbit.

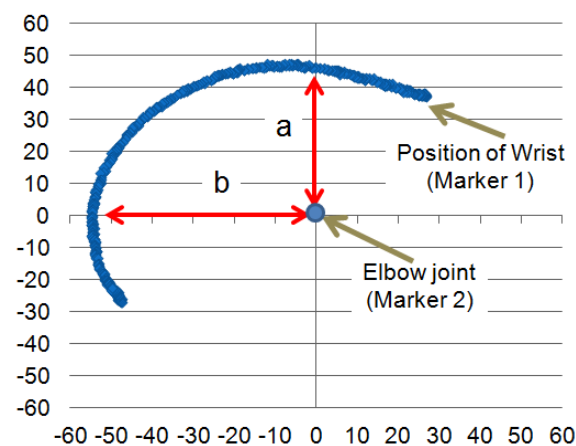

Figure 14 *Ellipse orbit of wrist extension effect*

The ulna bone is built with a mechanical spring structure to allow movement while following the ellipse cam. The ulna bone is separated into two parts; the fixed and moveable ulna. The spring is attached to the fixed ulna bone on the inside with the moveable ulna bone on the outside, giving the outside ulna bone the ability to move freely following the cam shape in one degree of freedom. This is to enable the mechanism of a cam follower to facilitate the ellipse movement of the forearm, generating the effects of a wrist extension.

The forearm is built with separate ulna and radius bones attached to the elbow joint shaft. Figure 16 illustrates the cross-sectional drawing of the ulna bone and the radius bone. Each bone performs a different function. The radius bone is built with the ability to perform pronation and supination movements. With the aim of providing these movements, a ball joint spherical bearing is used. The ball joint spherical bearing is able to create 30 degrees of angular displacement. A healthy human requires 50 degrees of pronation and 50 degrees of supination movements to accomplish daily activities [58]. In rehabilitation, the imitation of 30 degrees pronation and supination movements has already met the requirements of therapists.

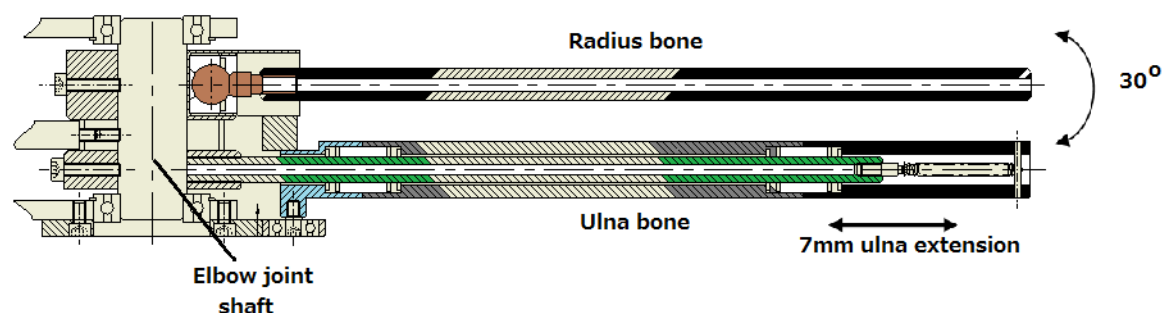

Figure 15 *Moveable ulna structure and radius angle movement*

Figure 16 shows the details of the cam and the position of the ulna bone attached to the cam follower. Meanwhile, the stiffness of the symptoms is reproduced at the elbow joint by providing resistance when therapists apply extension movements to the part-task trainer.

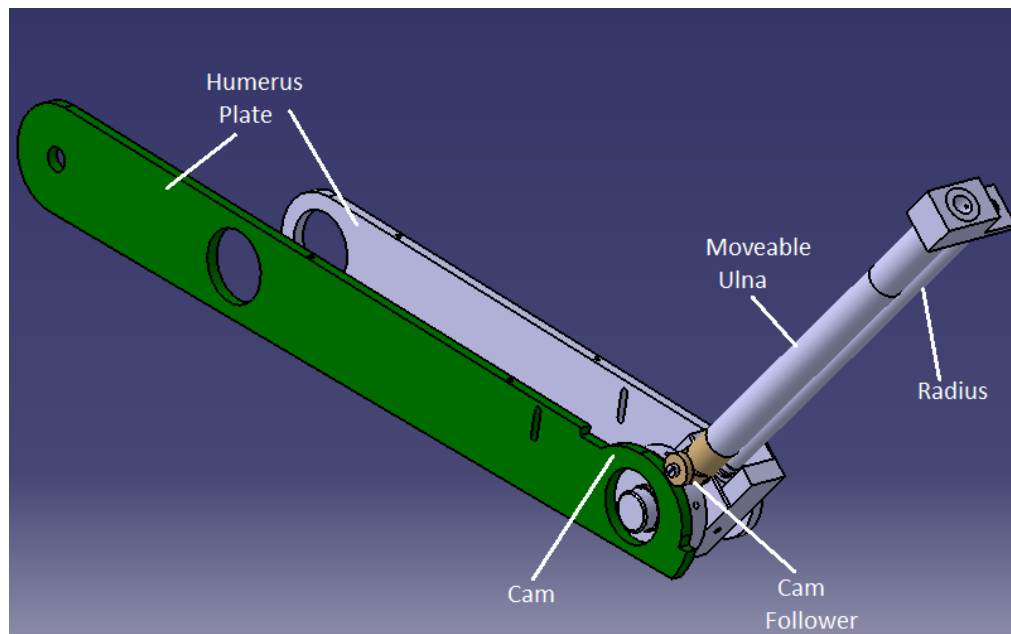

Figure 16 *Cam follower at the elbow joint*

Referring to Figure 17, the shaft of the elbow joint is connected to the shoulder shaft using a cantilever mechanism of a belt and pulley. The actuators that transfer the force to the shoulder shaft and the belt that transfers the force to the elbow joint shaft are placed between the two humerus plates. The artificial human arm is built from the shoulder area with a range of motion of -45 degrees to +45 degrees from a horizontal plane. By providing a range of angles, trainee therapists and physicians may take various positions depending on the different positions of the patient. The forearm is built with a 140-degree range of motion, imitating the human forearm's movement. The fabricated part-task trainer is supported with two shafts, the shoulder shaft and the elbow joint shaft. The elbow joint is supported by the humerus. The humerus is built with two plates, both on the sides, to

support the elbow joint, which is the most important structure in reproducing the disorder symptoms.

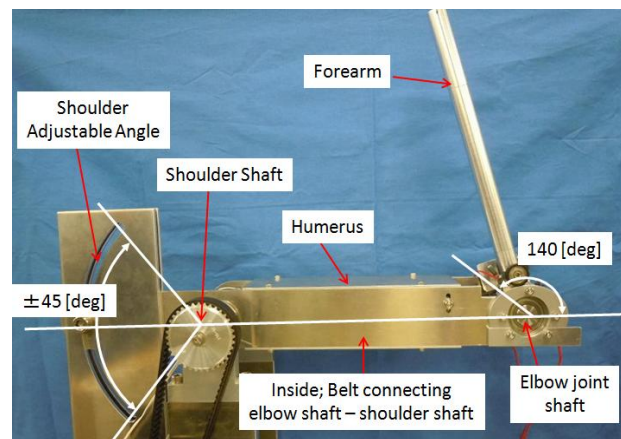

Figure 17 Angle Range of Artificial Human Arm Simulator

The part-task trainer system is built with a set of DC servo motor manufactured by SANYO Corp. (L404-011NE) and a Magneto-Rheological (MR) brake by LORD Corp. (RD-2087-01), to reproduce the stiffness as in the elbow of a patient suffering from an upper limb disorder. An MR brake is an electronic brake control system that employs the brake-by-wire system which is currently endorsed by the automotive industry [59]. The MR brake provides a simpler, quieter and faster response compared to other hydraulic brake systems. In this system, it is used to produce resistance, which was said to provide similar stiffness to human muscle resistance. A few rehabilitation devices have been found to apply Magneto-rheological fluid in their system [18, 60, 61]. In the current stage, the part-task trainer is built to reproduce the symptoms of spasticity. For constant stiffness, the MR brake is used to reproduce the resistance and the DC servo motor is used to support fluid particle settling of the MR brake during muscle losing stiffness condition.

Application Scenarios:

Five scenario applications have been designed based on the clinical data collections and the prototypes built. The scenario cases are labelled in Table 9 and shown in Figure 18 to Figure 23.

Table 9 *Application scenarios to emulate spasticity symptoms*

Case Type	Descriptions
Case A	Slow Stretch
Case B	Fast Stretch MAS 1
Case C	Fast Stretch MAS 1+
Case D	Fast Stretch MAS 2
Case E	Fast Stretch MAS 3

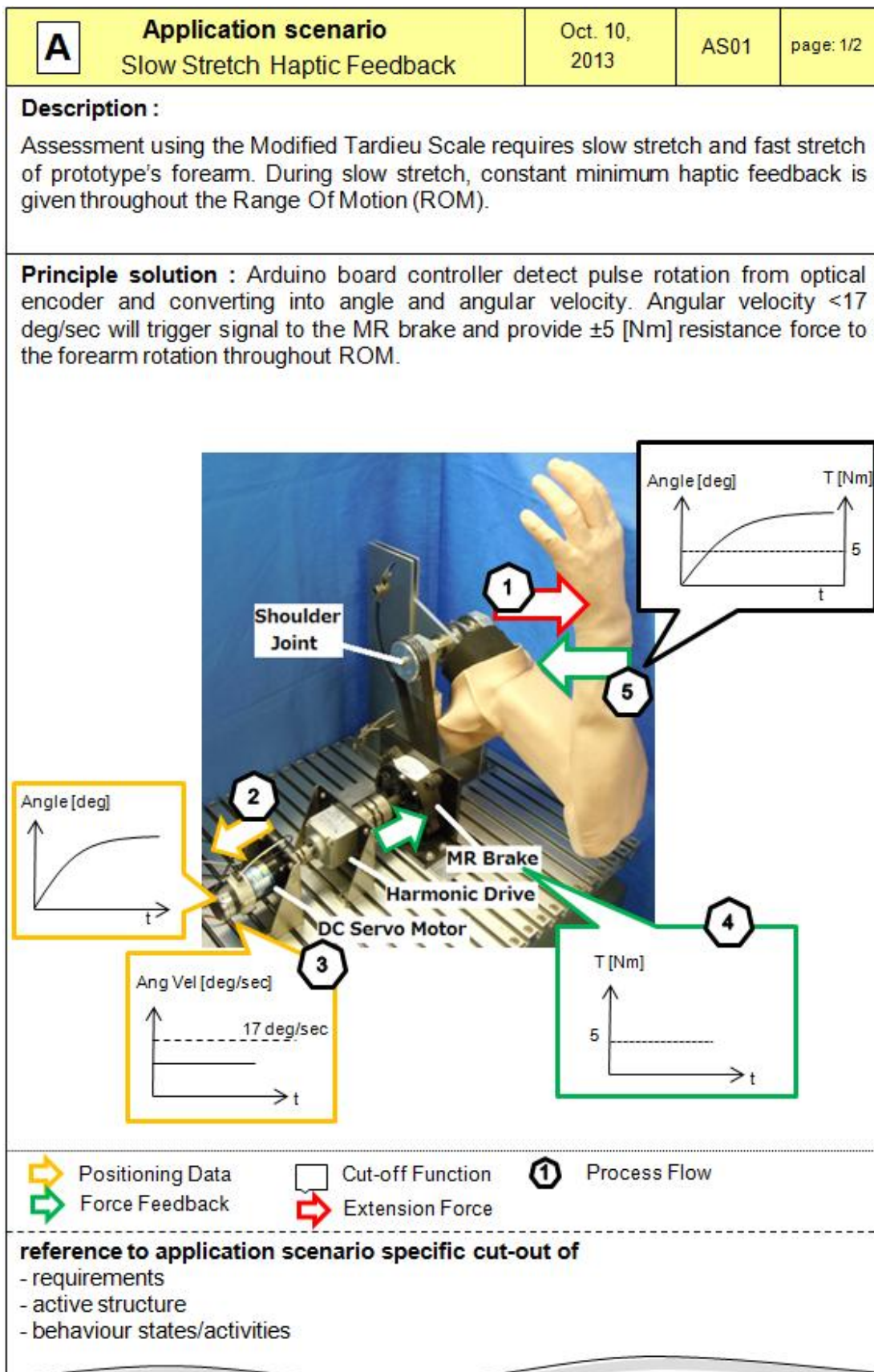

Figure 18 Application A: Slow stretch haptic feedback for all MAS level

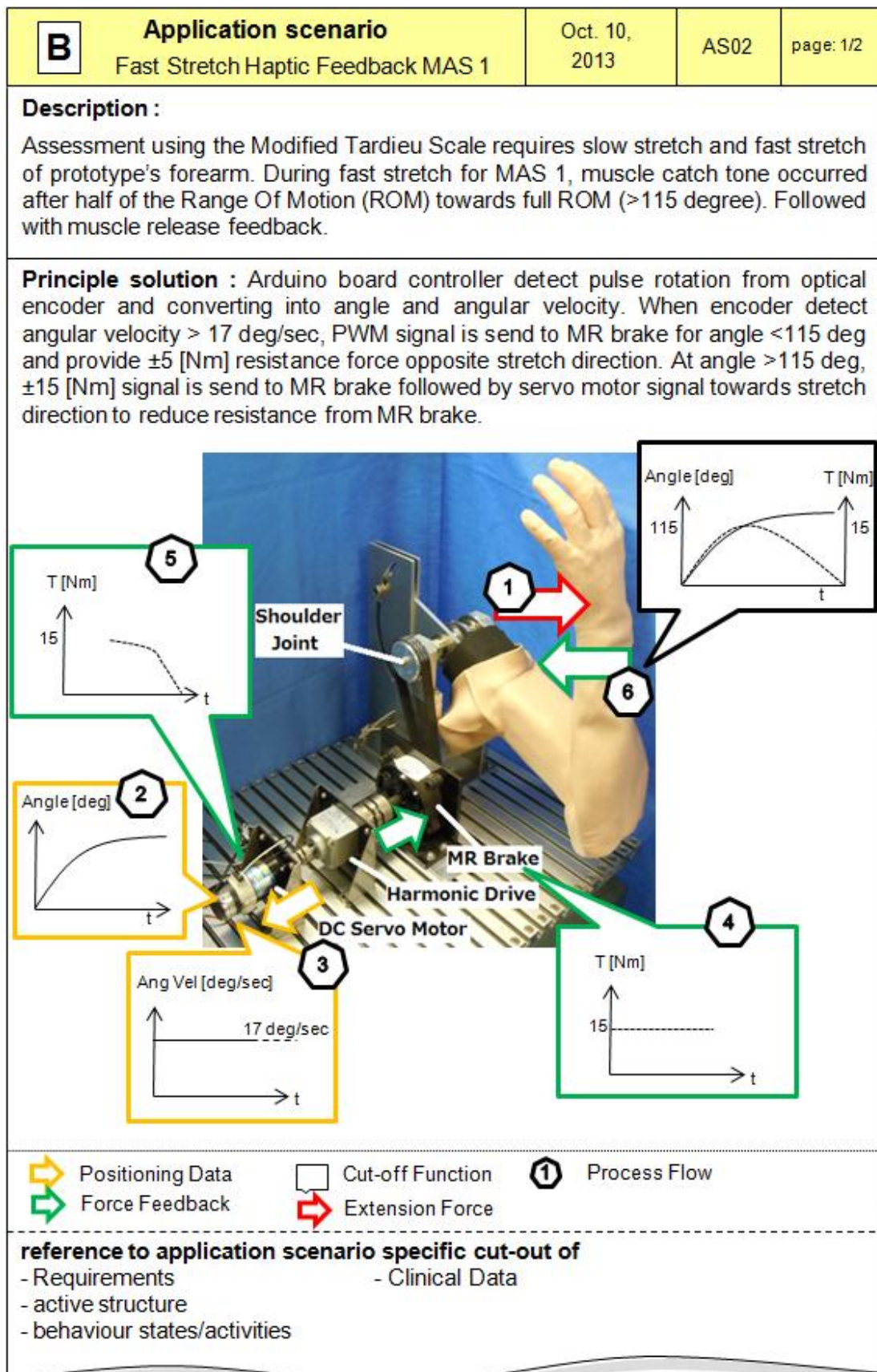

Figure 19 Application B: MAS 1 fast stretch haptic feedback

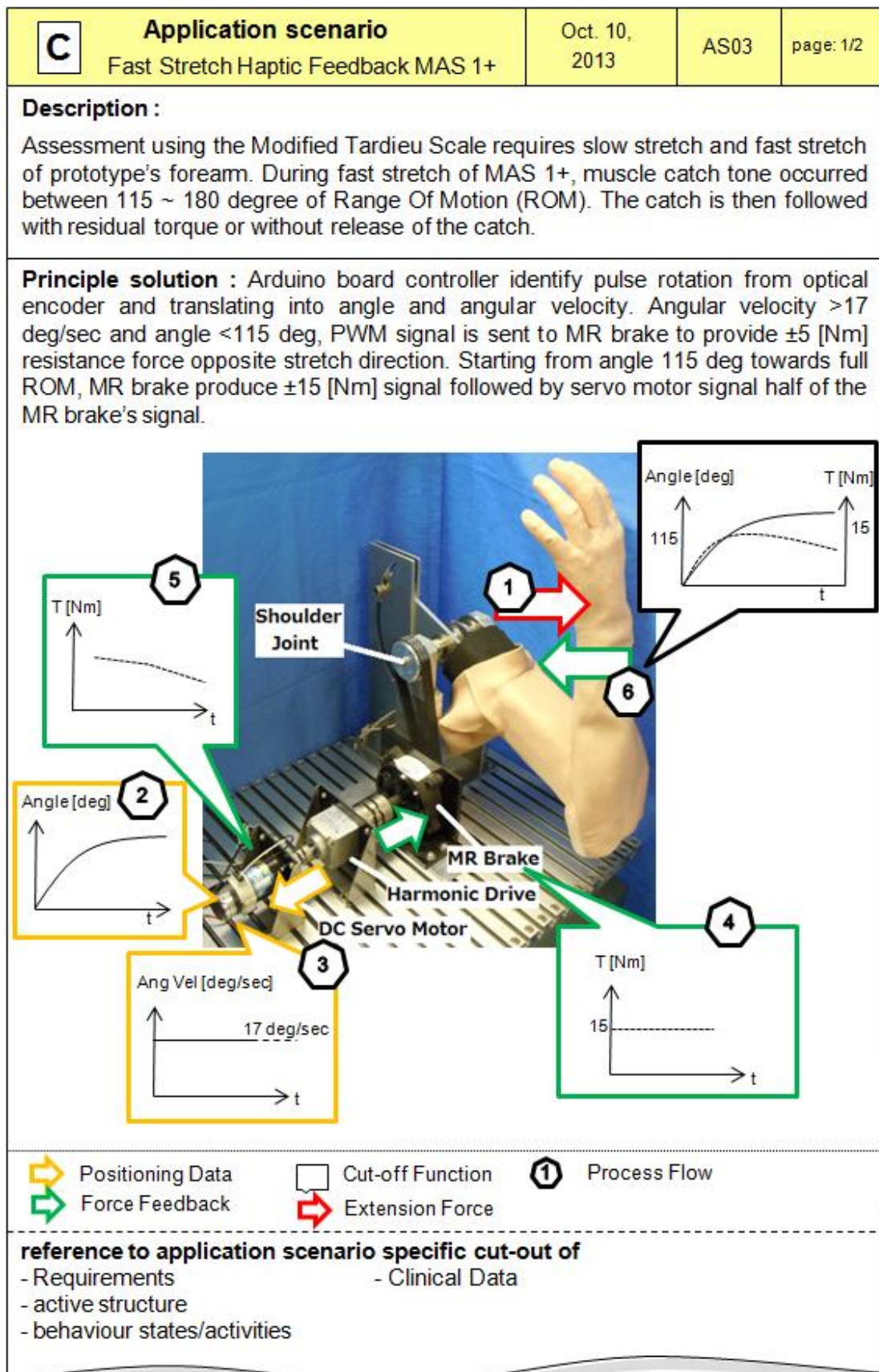

Figure 20 Application C: MAS 1+ fast stretch haptic feedback p1

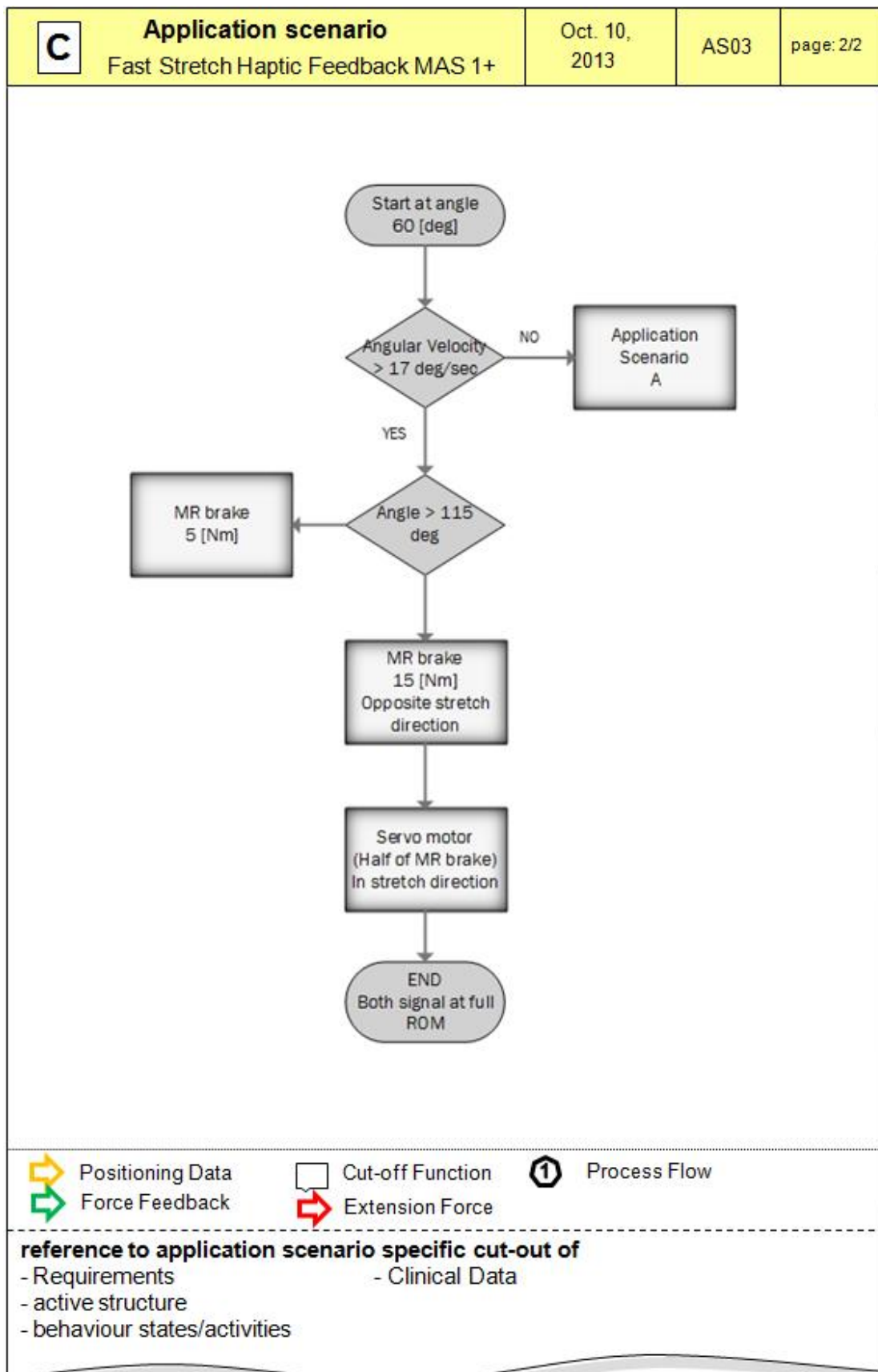

Figure 21 Application C: MAS 1+ fast stretch haptic feedback p2

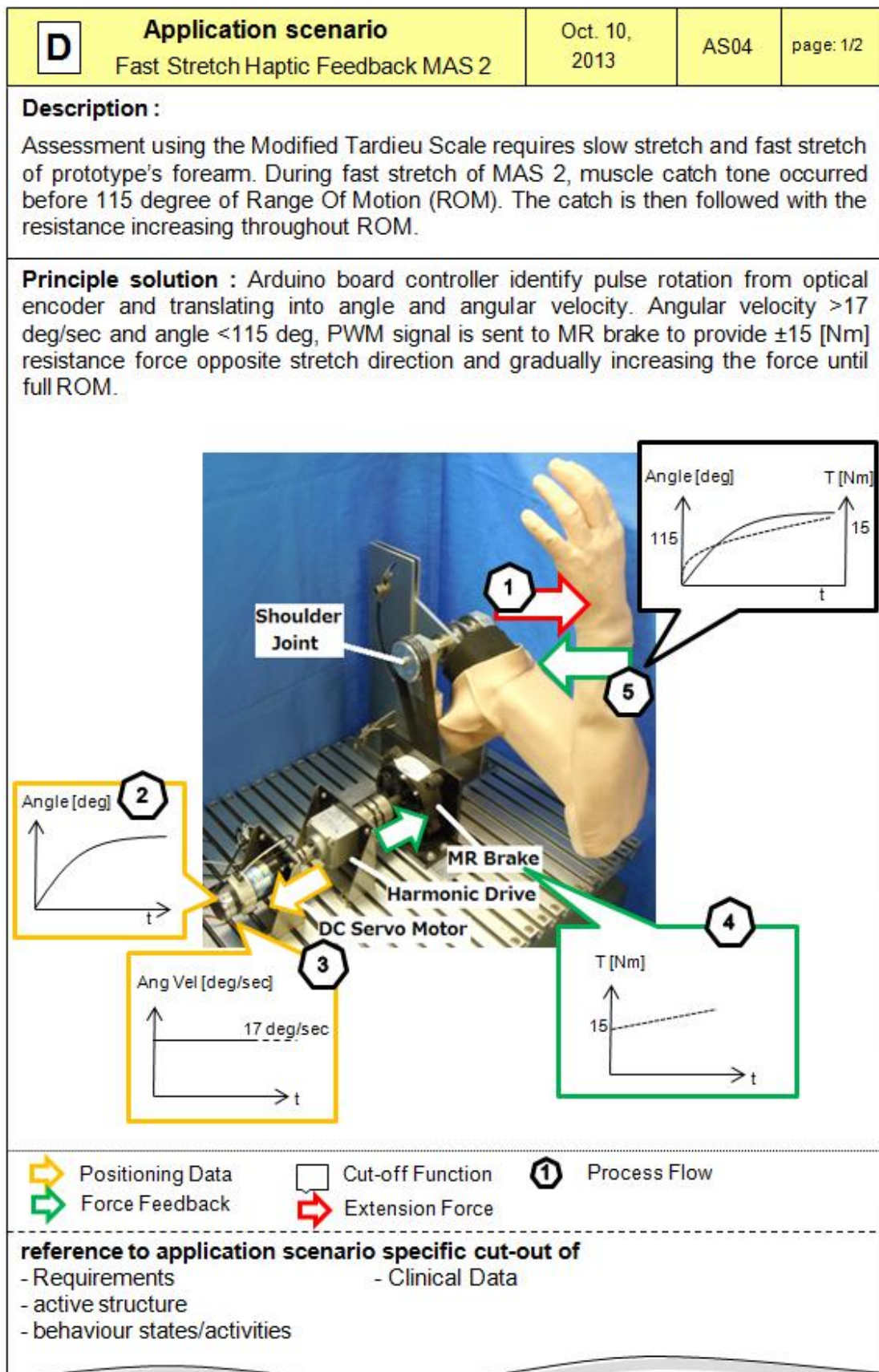

Figure 22 Application D: MAS 2 fast stretch haptic feedback

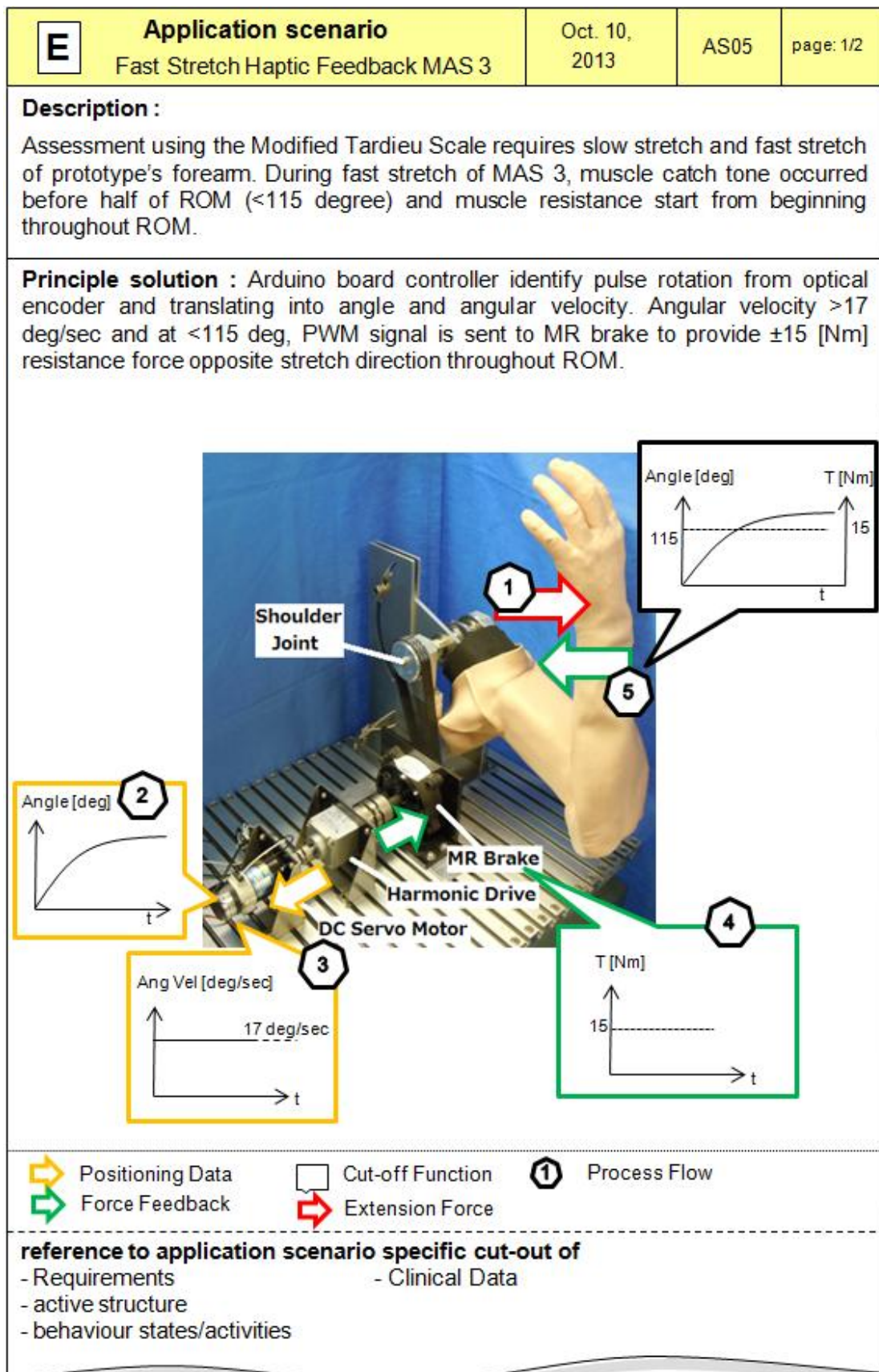

Figure 23 Application E: MAS 3 fast stretch haptic feedback

CHAPTER 6

CLINICAL DATABASE

6.1 Clinical Data Measurement

From active structure in Figure 13, we know that clinical database is a must in defining the quantitative characteristics of spasticity and in constructing the spasticity stiffness haptic feedback.

A series of quantitative assessments on upper limb spasticity was conducted by an experienced rehabilitation physician supported by a team of engineers. The ethics approval for this clinical assessment was applied through Research Ethics Committee of Universiti Teknologi MARA and later registered with the National Medical Research (NMRR) and Ethics Committee of the Ministry of Health Malaysia. The stroke patients are screened by a rehabilitation physician before the evaluation of spasticity using the MAS and Tardieu Scale. All subjects involved need to sign a consent form prior to the clinical measurement. The clinical measurement is conducted in the Clinical Training Centre at the Faculty of Medicine, Universiti Teknologi MARA, Malaysia before proceeding to the Sungai Buloh Hospital, Selangor.

The force induced by the rehabilitation physician to the patient's elbow joint angle during passive stretch motion of the forearm was measured. The Modified Tardieu Scale (MTS), spasticity angle and the Modified Ashworth Scale (MAS) will be applied for the evaluation of severity level. The measurement outcome includes angular position and muscle resistance force caused by patient's muscle activation. Such clinical database of upper limb spasticity symptoms is novel because it is the first database specific for Malaysian patients, which can be useful for studies on kinesiology.

6.1.1 Measurement Set-up

The assessment procedures are non-invasive in nature, which consists of pre-assessment, assessment and post assessment procedure. The procedures are elucidated in Figure 24.

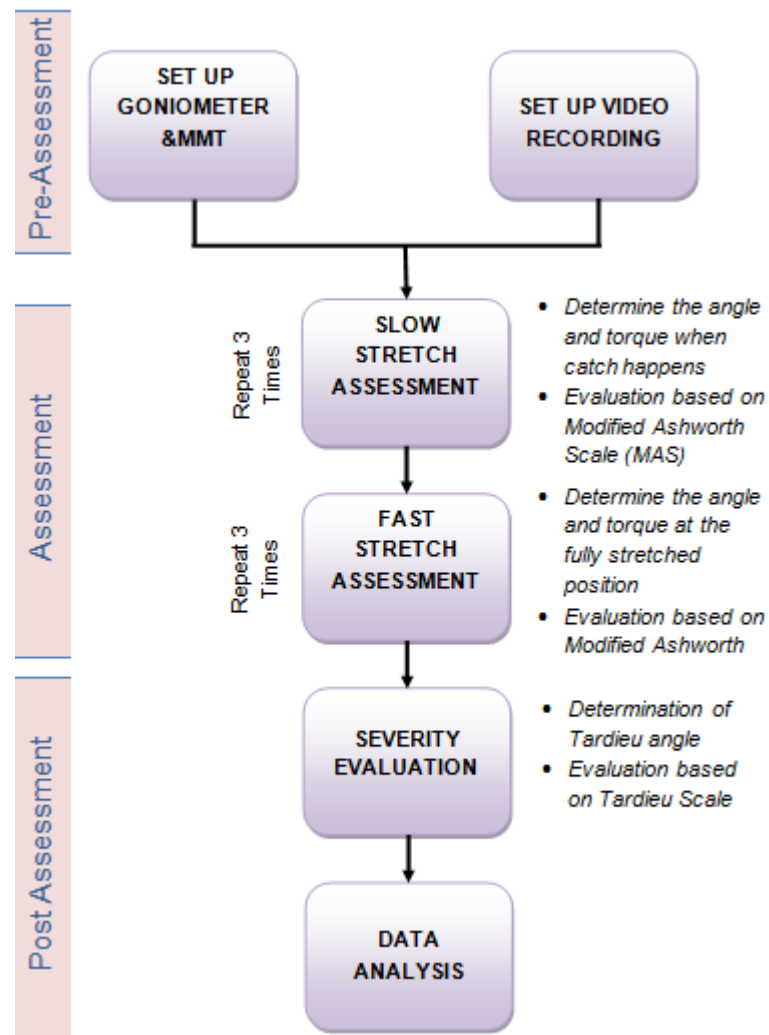

Figure 24 Flowchart of experimental protocol

The assessment procedure involves three procedures:

1) Pre-Assessment Procedure: Devices Set-up

The rehabilitation physician is supported by an engineering team during the clinical measurement, to handle the set-up and operation of digital goniometer and manual muscle tester. Figure 25 illustrates the system overview of the clinical measurement set-up.

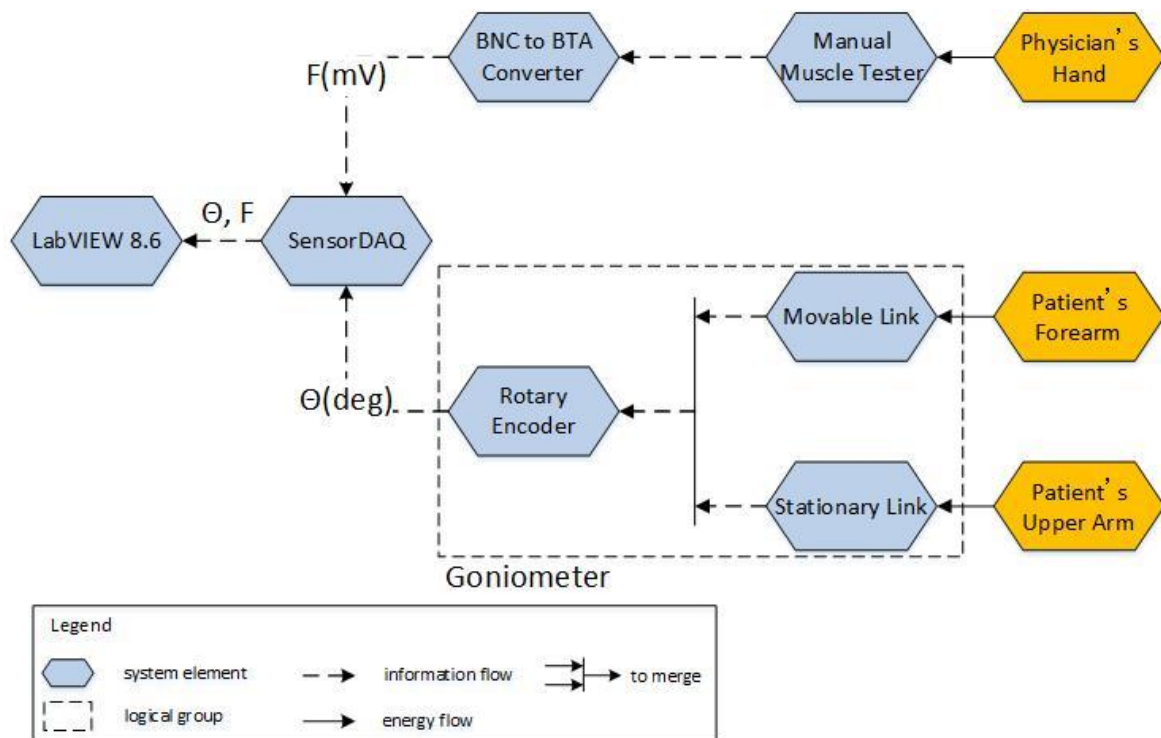

Figure 25 Measurement of devices set-up connection for the clinical data collection

Goniometer (GNM-BTA from Vernier) in Figure 26 is used to measure the range of motion of the elbow joint. It is a Vernier product with an angle sensor attached to a metal stationary arm. It comes with a set of Velcro straps used to fix the sensor to patients' arm for measurements of the elbow joint movement as in Figure 27.



Figure 26 Goniometer - joint angle sensor attached to metal stationary arm



Figure 27 *Attaching goniometer to the patient*

On the other hand, a manual muscle tester (Mobie MT-100W) product of SakaiMed in Figure 28 is used to measure the force given by the rehabilitation physician to the forearm of the subjects during a passive stretch motion. The sensor was placed on the rehabilitation physician's palm.



Figure 28 *Manual muscle tester*

2) Assessment Procedure: Parameters Measurements

Parameters measurements were conducted with a similar procedure where a therapist or physician conducts a rehabilitation session/assessment to the patient suffering upper limb spasticity. The difference is that during this procedure, the following parameters were measured:

- 1) Elbow joint angle of the patient
- 2) Forces given by the therapist to the patient
- 3) Position of the therapist's hand replacement on the patient

The assessment procedure involves three steps:

Slow Motion Assessment: The therapist stretches the forearm of the patient as slow as he or she could manage until it reaches full stretched position to determine the angle θ_1 and the torque T_1 at the fully stretched position, from the goniometer and the muscle strength meter.

Fast Motion Assessment: The therapist stretches the forearm of the patient as fast as he or she could manage and a catch is expected to happen, to determine the angle θ_2 and the torque T_2 when catch happens, from the goniometer and the muscle strength meter.

Evaluation of Severity Level: The difference in terms of the angular position detected during the fast and slow motion assessments can be used to determine the level of severity. Both the Modified Tardieu Scale and the Modified Ashworth Scale were applied.

These steps were repeated three times.

The examiner/therapist must have the skill to perform the following for the elbow joint and its motion:

- 1) Position and stabilise correctly
- 2) Move the forearm through the appropriate range of motions
- 3) Determine the end of the range of motion
- 4) Align the measuring instrument with landmarks
- 5) Read the measuring instrument
- 6) Record measurements correctly

3) Post Assessment Procedure: Data Analysis

The collected data was analysed in term of the angular velocity of the patients' movements and characteristics of each symptoms and level after the session completed. From the evaluation data, spasticity characteristics parameter was extracted for the purpose of MATLAB mathematical modelling simulation and later, applied into the system's prototype.

6.1.2 Subjects Screening

The inclusion criteria for the screening of patients included the following:

- 1) Adult, above 18 years old
- 2) Diagnosed as central nerve system disorders
- 3) Consent of caregiver
- 4) Ability to understand and follow commands

It involves interviewing and examining the subject, and reviewing records to obtain an accurate description of current symptoms; functional abilities; and medical history.

6.2 Clinical Data Analysis

LabVIEW 8.6 was utilised to acquire raw data of forearm angle from Vernier goniometer during passive stretch and the force exerted from the physician from Mobie WT-100. Figure 29 shows the raw screen data of goniometer [deg] and force sensor [mV] from LabVIEW 8.6 during data recording which usually took 1 - 2 minutes for three slow stretch trials and three fast stretch trials depending on patients' condition. Generated data was then analysed with MATLAB software in order to smooth the data and separating each stretching session. Figure 30 shows the sample of analysis code to generate angular velocity and moment by multiplying calibrated force with the arm length of each patient measured during data recording.

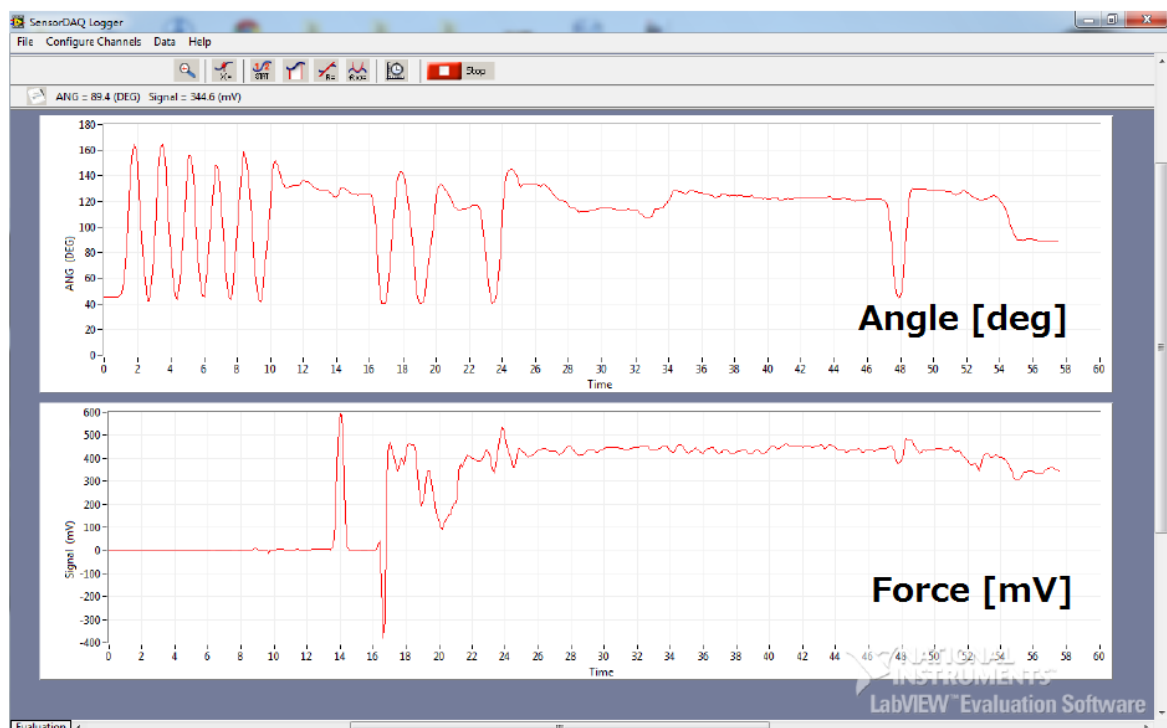

Figure 29 LabVIEW 8.6 screen during data recording

```

%fast extension patient 9
p9f1 = xlsread('patient 9.xlsx','Data','D535:D579');
p9f2 = xlsread('patient 9.xlsx','Data','D584:D599');
anglerawp9f1 = xlsread('patient 9.xlsx','Data','B535:B579');
anglerawp9f2 = xlsread('patient 9.xlsx','Data','B584:B599');

%%%------ check each data within range-----
b1 = abs(anglerawp9f1);
b2 = abs(anglerawp9f2);

for n=1:length(b1)
    m=max(b1);
    if m > 180;
        c1(n,1)=b1(n,1)-(m-180);
    end
end

for n=1:length(b2)
    m=max(b2);
    if m > 180;
        c2(n,1)=b2(n,1)-(m-180);
    end
end

% -----Angle -----

YY1 = smooth (c1,'moving');
YY2 = smooth (c2,'moving');

%-----Moment-----

dist=0.2475;
MM1 = p9f1.*dist;
MM2 = p9f2.*dist;

%-----Angular Velocity-----

for p=1:length(YY1)-1
    AGV1(p,1) = YY1(p+1,1)-YY1(p,1);
end

for p=1:length(YY2)-1
    AGV2(p,1) = YY2(p+1,1)-YY2(p,1);
end

%-----Plot-----

figure(1)
subplot (311);plot (MM1,'-ro');
ylabel('Moment[Nm]');

subplot (312);plot (YY1,'-r+');
ylabel('Ang Disp [deg]');

subplot (313);plot (AGV1,'-r*');
ylabel('Ang Vel [deg/sec]'); xlabel('Time[sec]');

```

Figure 30 Sample of data analysis in MATLAB code

6.3 Clinical Data Results

Table 10 describes the diagnostic data of the study sample. Not all the patient's symptom was caused by stroke. Types of stroke were classified as either ischaemic, haemorrhagic or unspecified. Mechanism of cell injury may be caused by a deficit of oxygen and nutrients in the brain cells or toxicity due to a rupture or a blockage of a blood vessel. Details of each cause are elaborated in Table 11.

Table 10 *Diagnostic data for study participants*

ID	Gender	Cause	Side	MAS Score	Manual Tardieu Angle
1	Female	Ischaemic Stroke	Left	1	0
2	Male	Stroke unspecified	Left	2	56.67
3	Male	Stroke unspecified	Left	1+	54
4	Male	Haemorrhagic Stroke	Right	0	-
5	Male	Ischaemic Stroke	Right	1+	40
6	Female	Ischaemic Stroke	Left	1+	45
7	Male	Ischaemic Stroke	Left	0	-
8	Female	Stroke unspecified	Left	1+	60
9	Male	Stroke unspecified	Right	1+	35
10	Female	Ischaemic Stroke	Right	1+	46.67
11	Male	Traumatic Brain Injury	Left	2	78.33
12	Male	Ischaemic Stroke	Left	1	16.67
13	Male	Traumatic Brain Injury	Right	0	-

14	Male	Traumatic Brain Injury	Right	1+	53.3
15	Male	Road Traffic Accident	Left	1+	70
16	Male	Ischaemic Stroke	Left	1+	10
17	Male	Ischaemic Stroke	Right	1+	46.67
18	Male	Haemorrhagic Stroke	Right	1+	16.67
19	Male	Haemorrhagic Stroke	Right	1	-

**Tardieu Angle is not applicable for MAS 0.

Table 11 Description of the cause of spasticity

Condition/Diagnosis	Descriptions
Haemorrhagic Stroke	Strokes caused by a break in the wall of a blood vessel in the brain
Ischaemic Stroke	Strokes caused by a deficit in blood supply due to blockages of a blood vessel in the brain
Traumatic Brain Injury	Head injuries may cause direct trauma, haemorrhage, swelling and ischaemia in the brain tissue and the layers that surround the brain. Some head injuries cause changes in brain function. This is called a traumatic brain injury which lead to spasticity.
Spinal Cord Injury	The spinal cord is a part of the central nervous system. 60% of the spinally injuries are in the 16-30 age group result from road traffic accidents which later develop loss of muscle function [62]. This type of injury can also cause spasticity.
Other Non-traumatic Central Nervous System Injury	Conditions that affect the brain and spinal cord may lead to spasticity. These include infections, tumours, blood vessel malformations, anoxic injuries, congenital disorders and many more.

6.3.1 Results on Comparison MAS Level

Discussions on the clinical results was referred to the general pattern of spasticity illustrated in Table 4 *Illustration of general pattern of Modified Ashworth Scale (MAS) in quantitative hypothesis*. Figure 31 shows the results of haemorrhagic stroke patient of patient 4. No catch angle occurred during fast stretch or slow stretch, thus showing that the patient is categorised as having no spasticity with a Modified Ashworth Scale score of level 0.

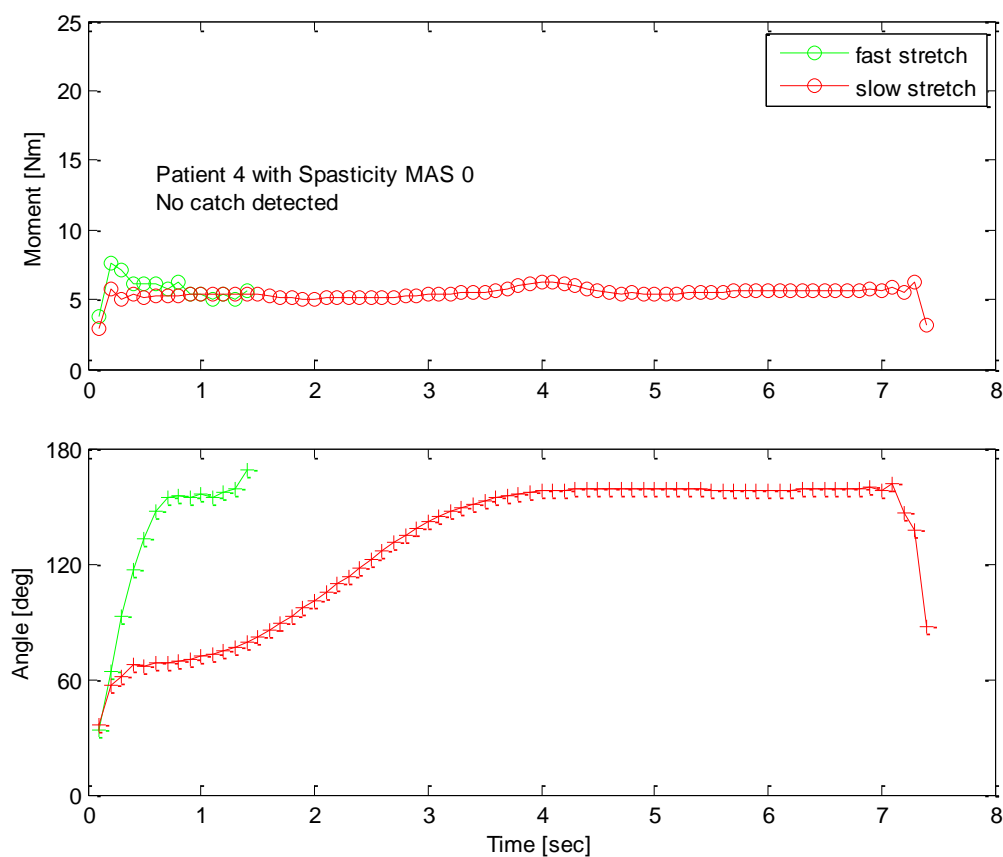

Figure 31 Results for Patient 4 with MAS 0 during slow and fast stretch

Figure 32 shows the results of ischaemic stroke patient 12 with mild spasticity of MAS score 1. During fast motion stretch, a catch occurred at angle 174 degrees where the peak of the muscle resistance is shown at 12.44 [Nm]. According to the rehabilitation physician, the resistance was released soon after the catch occurred. The catch angle occurred in between 90 - 180 degrees thus showing that the patient is under level 1 of Modified Ashworth Scale. The maximum angle of motion is at 178 degrees, when the forearm was stretched in slow motion. The slow motion stretch did not show any sudden increase in the force given by the rehabilitation physician and the elbow angle shows an increment contrasting the fast motion stretch. The Tardieu angle is measured by the difference between fully stretched angle and the position angle when the catch occurred.

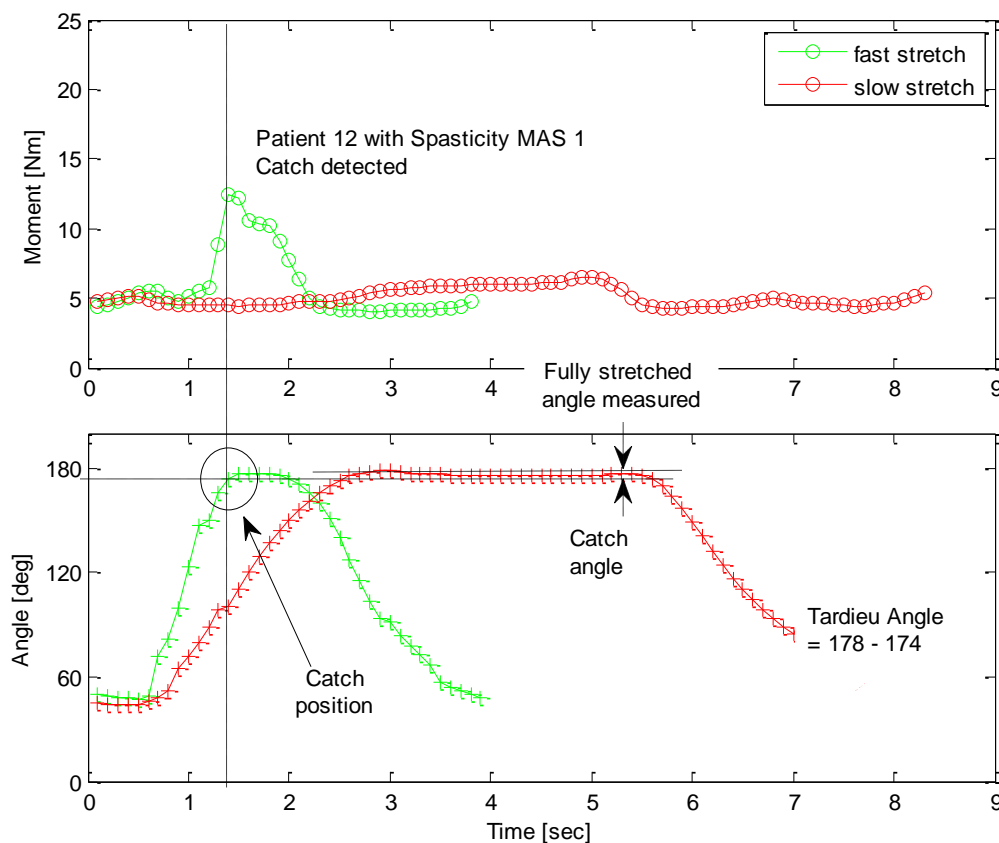

Figure 32 Results for Patient 12 with MAS 1 during slow and fast stretch

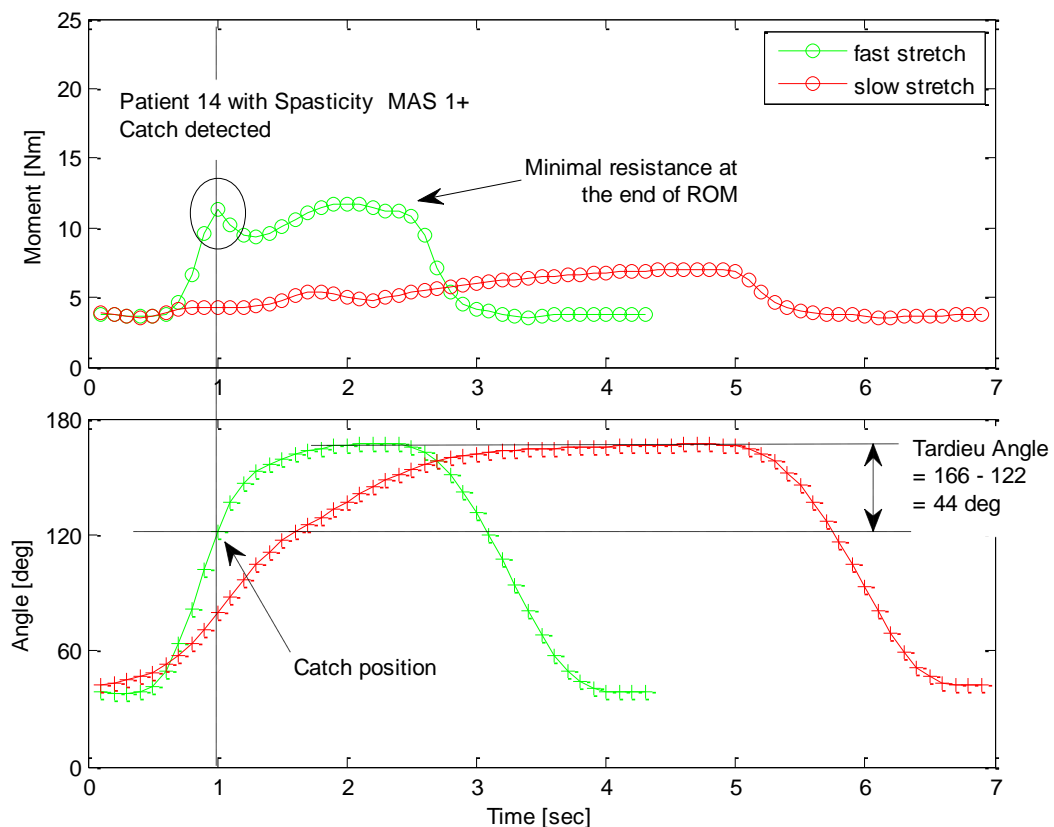

Figure 33 Results for Patient 14 with MAS 1+ during slow and fast stretch

On the other hand, Figure 33 shows the result of Patient 14 with Spasticity MAS score 1+. The maximum Range of Motion (ROM) is at 166 degree. Catch occurred at 122 degree (after half of ROM at 110 degree to full ROM at 180 degree), with minimal resistance left throughout the remainder of the ROM until the rehabilitation physician released the manual muscle tester. The Tardieu angle increased with the increment of MAS level.

Results for Spasticity MAS score 2 for Patient 11 is shown in Figure 34. During fast stretch, catch occurred at 96 degree with 152 degree of full ROM. Normally, patient with MAS 2, the catch will occur halfway through the ROM and for this patient it occurred

at 96 degree. The Tardieu angle is measured at 56 degree. After the catch occurred, with the difference of MAS 1 and MAS 1+, the resistance persisted thus represented the patient score as MAS 2.

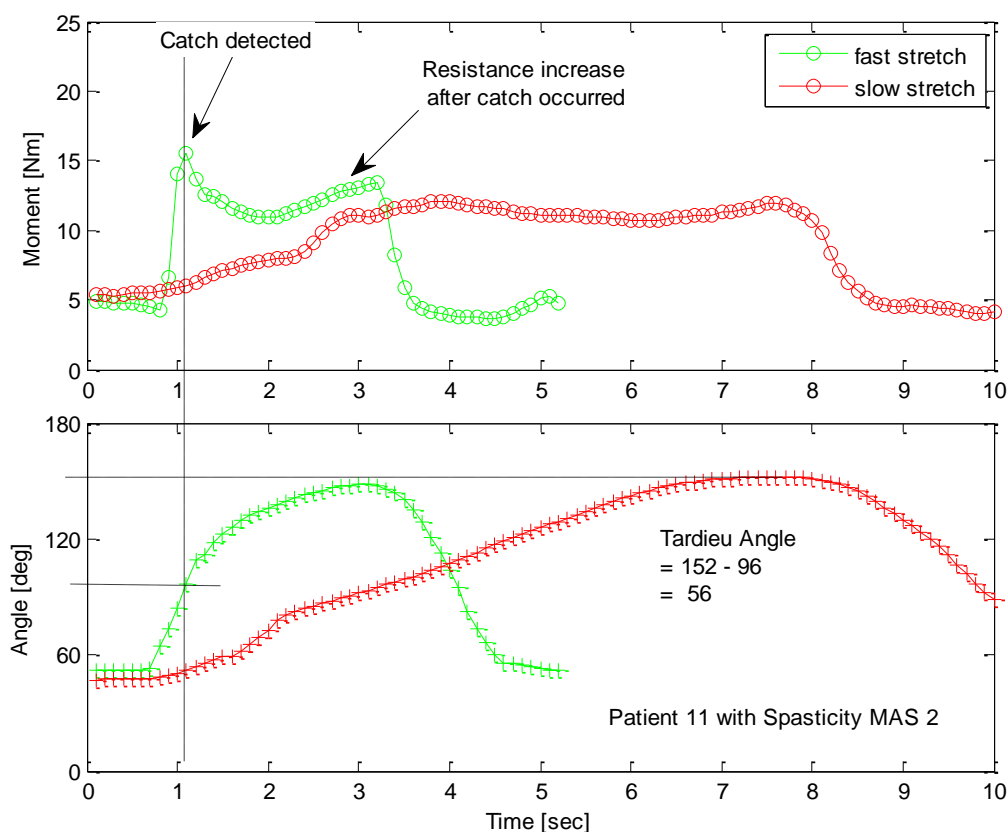

Figure 34 Results for Patient 11 with MAS 2 during slow and fast stretch

6.3.2 Intra-rater reliability analysis

In this section, the intra-rater reliability of the stretch speed from Modified Tardieu Scale was investigated. Intra-class Correlation Coefficient (ICC) was used as the statistical measure to find out intra-rater reliability as in [63, 64]. The ICC is a measurement method to define reliability of measurements. The ICC has six different formulas based on design of the study and the type of measurements taken. ICC types can be express with ICC

(*model, form*) where, Model 1: subject is assessed by different set of randomly selected raters (which is very rare); Model 2: each subject is assessed by each rater that has been randomly selected and; Model 3: each subject is assessed by each rater, and the rater are the only rater of interest. The form reflects whether the reliability is calculated on a single measurement of calculated on the average of two or more measurements.

Table 12 Intra-class Correlation Coefficients Description; ICC (*model, type*)

ICC Type	Description
ICC (1,1)	Each subject is assessed by a different set of randomly selected raters, and the reliability is calculated from a single measurement. Uncommonly used in clinical reliability studies.
ICC (1,k)	As above, but reliability is calculated by taking an average of the k rater's measurements.
ICC (2,1)	Each subject is measured by each rater, and raters are considered representative of a larger population of similar raters. Reliability is calculated from a single measurement.
ICC (2,k)	As above, but reliability is calculated by taking an average of the k raters' measurements.
ICC (3,1)	Each subject is assessed by each rater, but the raters are the only raters of interest. Reliability is calculated from a single measurement.
ICC (3,k)	As above, but reliability is calculated by taking an average of the k raters' measurements.

ICC can be interpreted as; <0.2 poor agreement, 0.21 - 0.4 fair agreement, 0.41 - 0.6 moderate agreement, 0.61 - 0.8 good agreement and 0.81 - 1.0 very good agreement. With reference to [65], ICC model 3 was used to determine intra-rater reliability. However in this research, the ICC was calculated from the stretch speed for each different MAS level which was similar to reference in [66] where ICC model 2 was used to determine intra-rater reliability within session. Therefore, the ICC (2, 1) measurement method with 95% confidence intervals was applied. Data was analysed by MedCalc® (v15.8, 1993-

2015 MedCalc Software). In avoiding bias, one rater; a qualified experienced physician performed all the clinical assessments.

Intra-rater agreement for single measures fast stretch velocity for MAS 0, MAS 1, and MAS 1+ shows good to very good agreement of 0.8275, 0.6909, and 0.7929 respectively. The ICC agreement for slow stretch angular velocity for all MAS level is 0.964 with very good agreement. Details are shown in Table 13. Relevantly, it is harder to achieve constant fast stretch velocity between different MAS scores and which explains why the intra-rater agreement is different between slow stretch and fast stretch. For MAS 2, the number of subject was too small and not relevant for ICC measurement.

Table 13 Intra-rater reliability summarised in Intra-class Correlation Coefficient agreement

MAS Assessments	ICC for Intra-rater Within Session
Slow Stretch for All MAS Level	0.964
V _{FS} MAS 0	0.8275
V _{FS} MAS 1	0.6909
V _{FS} MAS 1+	0.7929
V _{FS} MAS 2	NA

MAS; Modified Ashworth Scale, ICC; Intra-class Correlation Coefficient, VFS; Fast Stretch Velocity, NA; an ICC that could not be calculated

Figure 35 and Figure 36 shows the range of fast and slow stretch velocity for each MAS score respectively. For each patient, two measurements (test-retest) were considered, in calculation for ICC and range of stretch velocity. Based on the ICC agreement rater reliability, we can clearly state that the range of fast stretch and slow stretch velocity are

applicable for other spasticity simulation modelling as well. Fast stretch velocity range from 10.9 - 26.1 [deg/sec] while slow stretch velocity range from 4.3 - 7.8 [deg/sec].

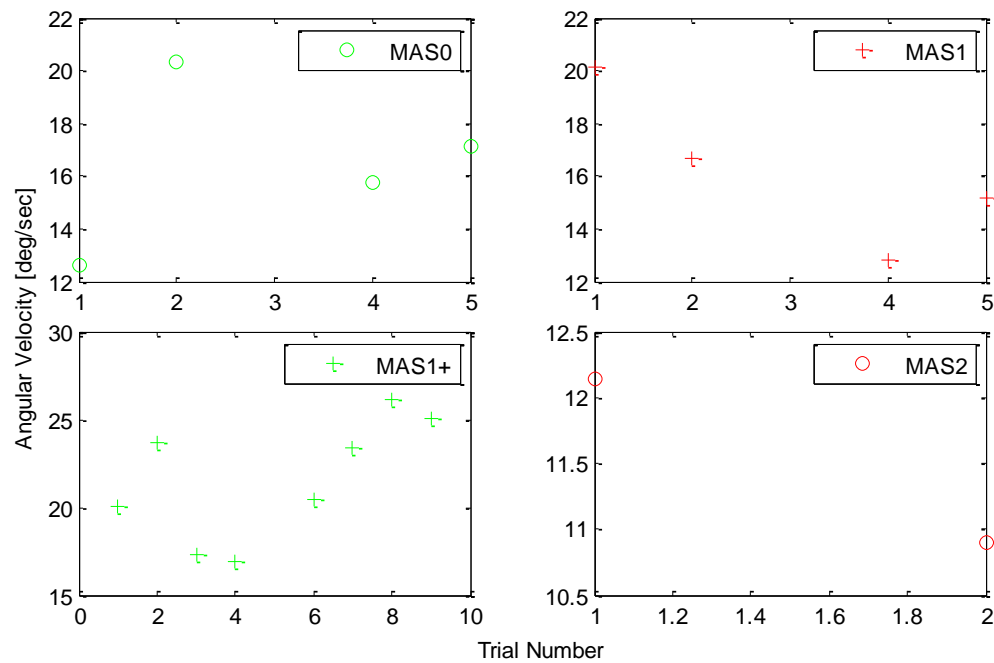

Figure 35 Range of fast stretch angular velocity for each MAS score

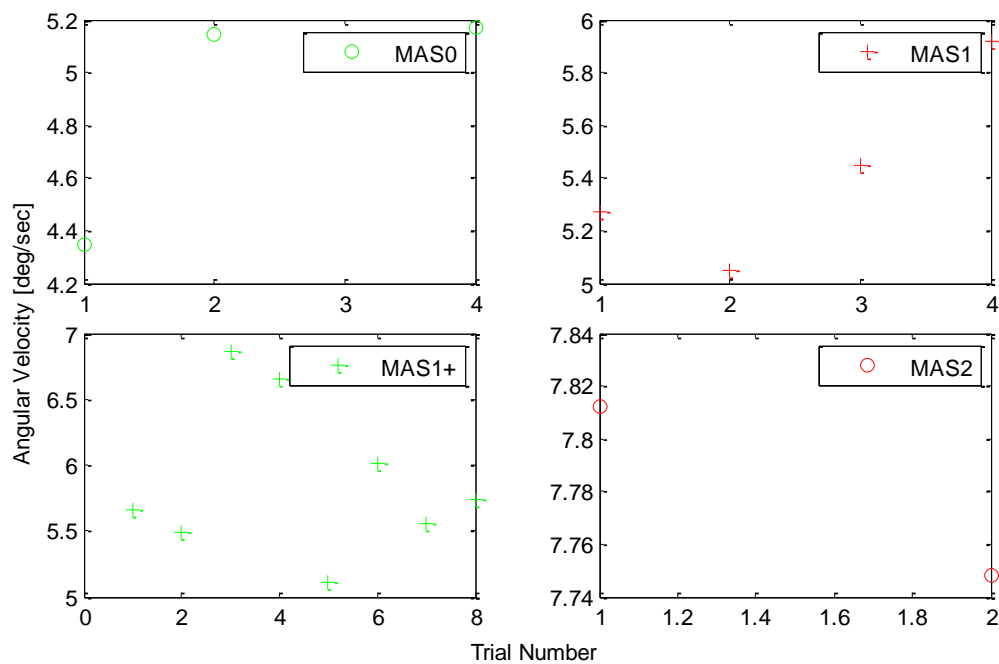

Figure 36 Range of slow stretch angular velocity for each MAS score

6.3.3 Determination of angular velocity for fast stretch threshold

With the aim of quantitatively comparing slow and fast stretch to evoke muscle catch later in the mathematical modelling and haptic feedback in the part-task trainer, a fast stretch threshold velocity needs to be classified.

Based on our clinical results; range of fast stretch velocity 10.9 - 26.1 [deg/sec] and range of slow stretch velocity 4.3 - 7.8 [deg/sec], we can assume that the threshold for fast stretch velocity where catch shall occurred was determine at 10 [deg/sec]. Therefore we are proposing that the threshold should be at;

$$\dot{\theta}_{\text{slow}} \leq 10 \frac{\text{deg}}{\text{sec}} \quad , \quad \dot{\theta}_{\text{fast}} \geq 10 \frac{\text{deg}}{\text{sec}}$$

6.4 Discussions

Based on the ethics application and presentation to the UiTM Research Ethics Committee on October 22, 2013, an ethics approval was granted on October 30, 2013 and measurements involving few subjects were conducted at the Clinical Training Centre (CTC), Faculty of Medicine, Sungai Buloh Campus. Yet, due to the lack of subjects in CTC, UiTM Sungai Buloh Campus, an application to conduct the measurements in Hospital Sungai Buloh has been applied through the Medical Research and Ethics Committee (MREC) under the Ministry of Health Malaysia. An approval letter was released on the 24th February 2014 and valid until 24th February 2015.

Despite of the 30 subjects target number, 19 subjects gave consents to participate in the measurements. Six subjects were targeted for each MAS level, however we were not able to accomplish the number due to the limited time given by the Ministry of Health Malaysia and the cooperation received from the caretaker especially for patients with higher level of MAS. Due to the imbalance number of subjects participated in this study, we have decided to focus on the subjects with MAS 1+ level which have the most number of subjects involved for further simulation analysis and programming system development.

Table 14 *Number of subjects participated for each MAS level*

MAS Level	Subjects Participated
0	3
1	3
1+	11
2	2
3	0
4	0

From the results, we have successfully measured spasticity and identified spasticity's characteristics quantitatively according to the illustrated general pattern of MAS assessment in Table 4. Muscle catch and muscle resistance can be expressed in moment [Nm] parameters.

Previous studies have focused on measuring the quantitative value of spasticity [17, 25, 67, 68], and an isokinetic dynamometer has reportedly shown a stronger direct relation to spasticity resistance and the angle measured using the Ashworth Scale [69]. Referring to these methods, we conducted a clinical quantitative spasticity measurement [54] and relayed the measurement using the Modified Ashworth Scale and the Modified Tardieu Scale. Our results supports previous research conducted by other group where we are actually able to assessed spasticity quantitatively based on the forearm catch angle and moment of muscle catch measured in real time. This shall be another field to be further explored under the same field of rehabilitation engineering.

CHAPTER 7

SPASTICITY MODELLING

7.1 Spasticity Mathematical Modelling

In Chapter 6, clinical database has been collected, analysed and discussed. From the clinical results, a spasticity mathematical modelling has been developed. With reference to [70] expressing resistance torque modelling for knee joint spasticity, upper limb spasticity can be divided into two types of stiffness; muscle tone catch and resistance through the ROM after the catch occurs due to the forearm's fast extension. Where T is the desired spasticity resistance, T_C is the resistance torque when catch occurred and T_E represents resistance torque at the end of the ROM after muscle catch;

$$T = T_C + T_E \quad (1)$$

Based on Eq. (1), the mathematical modelling of resistance torque before catch occurs is constant until a certain angular velocity; expressed as ω_0 . Thus, the torque provided during slow forearm extension is T_0 , a constant average torque extracted from slow extension clinical data measurement [54]. When angular velocity increases,

additional torque is added. Velocity-dependent spasticity muscle resistance is explained as follows;

$$T_c = \begin{cases} T_0 & |\dot{\theta}(t)| < \omega_0 \\ T_0 + c(|\dot{\theta}(t)| - \omega_0) & |\dot{\theta}(t)| \geq \omega_0 \end{cases} \quad (2)$$

Resistance torque at the end of the ROM is expressed as follows;

$$T_E = \begin{cases} k[\theta(t) + \rho \dot{\theta}(t) - \gamma(2\theta_E - \theta_X)] & (2\theta_E - \theta_X) < \theta(t) < \theta_X \\ 0 & otherwise \end{cases} \quad (3)$$

Where; $k > 0, \rho > 0, \gamma > 0$.

k is the proportional gain that reflects value of T_E , ρ is a constant gain that reflects torque distribution and γ changes the peak value of T_E . Other parameters are;

T_0 : Average torque during slow extension [Nm]

ω_0 : Angular velocity when catch occurs [deg/sec]

$\theta(t)$: Real time angular displacement [deg]

$\dot{\theta}(t)$: Real time angular velocity [deg/sec]

θ_E : Catch angle [deg]

θ_X : Maximum forearm extension angle [deg]

c : Viscosity coefficient [Nm.sec/deg]

k : Modulus of elasticity [Nm/deg]

The parameters characterised in this upper limb spasticity simulation model are derived from previous chapter conducted in compliance with MAS and MTS assessments.

From the clinical data, forearm angle, θ_E and angular velocity, ω_0 (where muscle catch occurred) were analysed in conjunction with the moment of the muscle catch, T_C (as shown in Figure 37). Furthermore, initial torque during slow stretching assessment, T_0 , maximum forearm extension angle, θ_X , viscosity coefficient, c , and modulus of elasticity, k , were extracted from the clinical data to form a precise spasticity stiffness model. Referring to Figure 37, viscosity coefficient is described as the ratio of the moment's slope, AB, with angular velocity, EF, when muscle catch occurred and modulus of elasticity is described as the ratio of the moment's slope, AB, and forearm angle, CD.

As described, spasticity emulation parameter sets were extracted from patient's clinical data. For preliminary spasticity simulation evaluation, four MAS 1+ patient's data were selected. The parameters extracted are shown in Table 15 and the simulation process is conducted following programming flowchart in Figure 38.

Table 15 Clinical data parameter sets of spasticity emulation for MAS1+

	Patient Number			
	9	10	14	15
T_0	5.66	6.86	5.11	5.59
ω_0	20.08	17.28	20.48	26.13
c	0.14	0.11	0.37	0.13
θ_E	142.40	120.10	121.90	151.90
k	0.12	0.07	0.09	0.04
θ_x	180	169	171	175

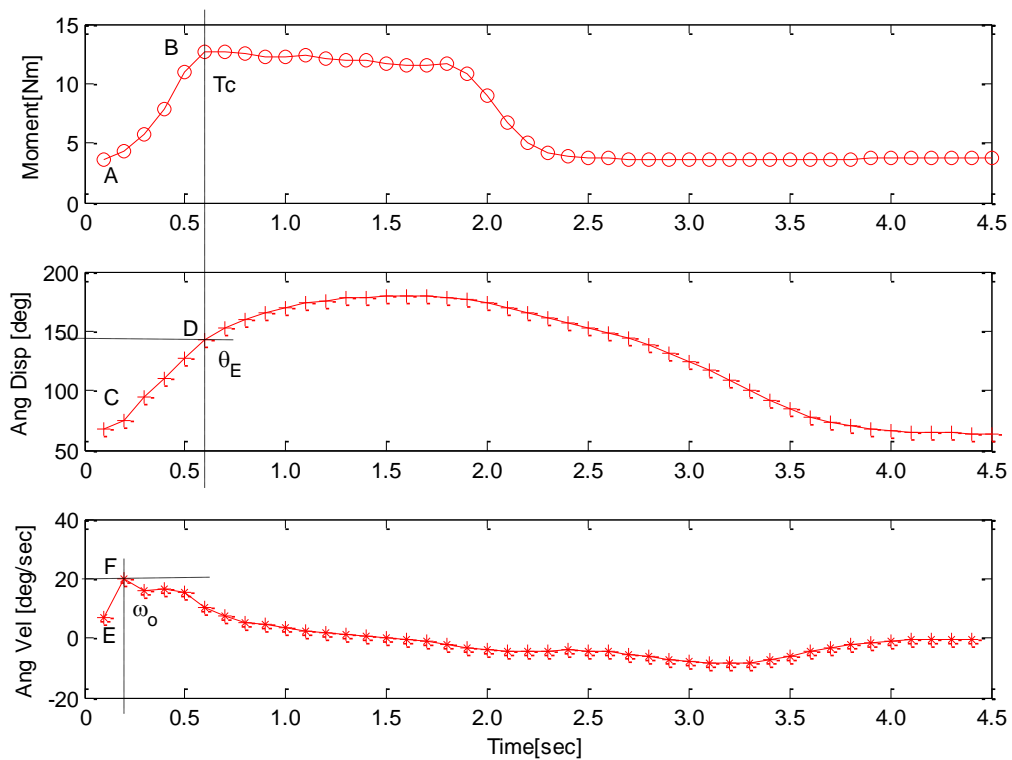
**Figure 37** Sample of patient's data with MAS1+ to show calculation of spasticity characterised parameters

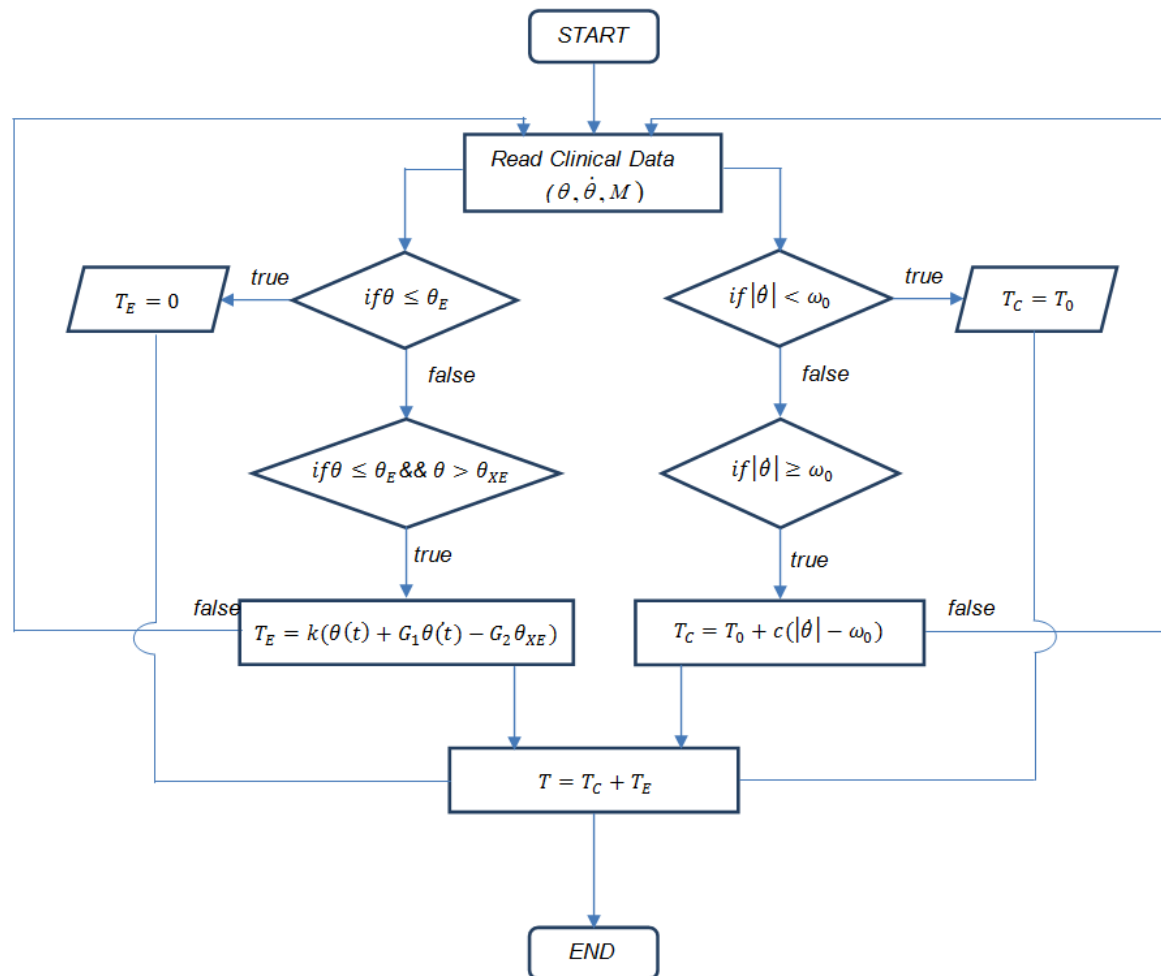

Figure 38 *MATLAB Programming flowchart for spasticity simulation*

7.2 Modelling Simulation Results

Clinical data parameters and equations were programmed in MATLAB computing language. Clinical data of angular displacement and angular velocity were used as input profiles to calculate spasticity stretch moment. Figure 39 to Figure 42 show the results of fast stretch simulated spasticity from mathematical equations for MAS 1+ level. Comparing actual clinical data MAS 1+ with simulated data, linear correlation coefficient, r shows strong positive linear correlations with r -value for Patient 9 ($r = 0.9290$), Patient 10 ($r = 0.8856$), Patient 14 ($r = 0.9517$) and Patient 15 ($r = 0.9099$).

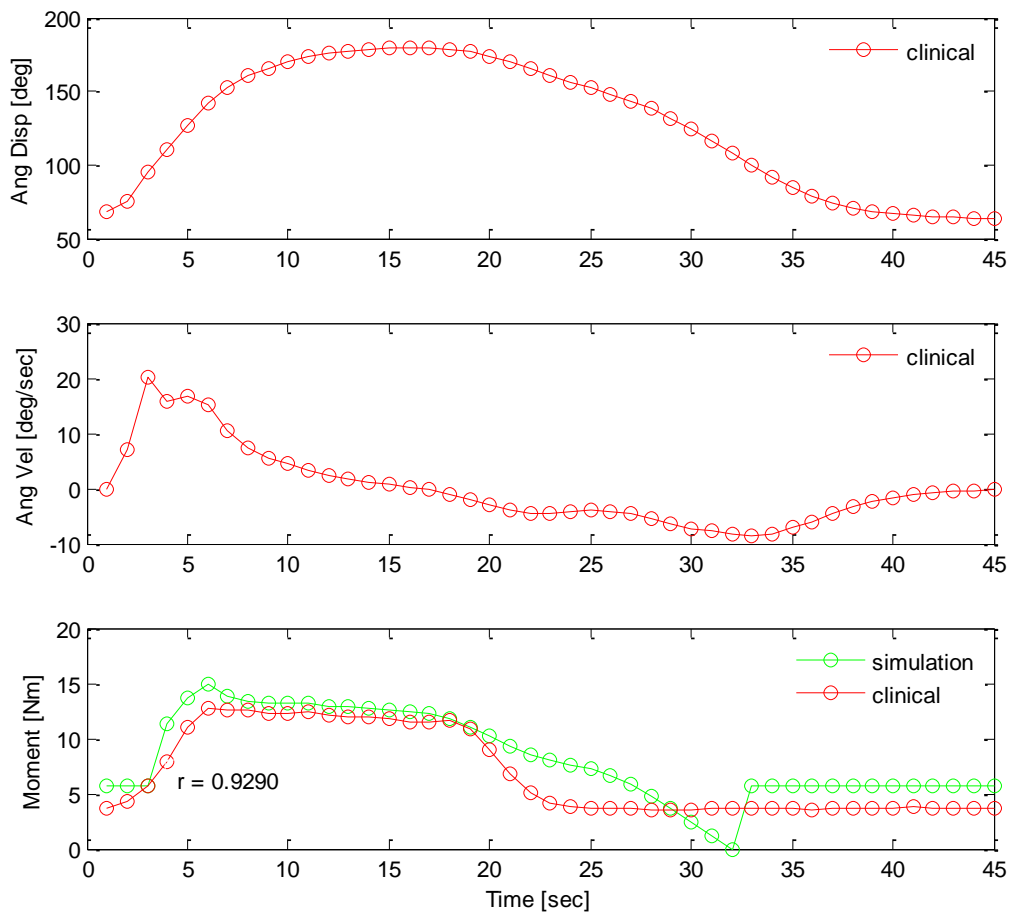

Figure 39 Simulation results of fast extension MAS1+ spasticity (Patient 9)

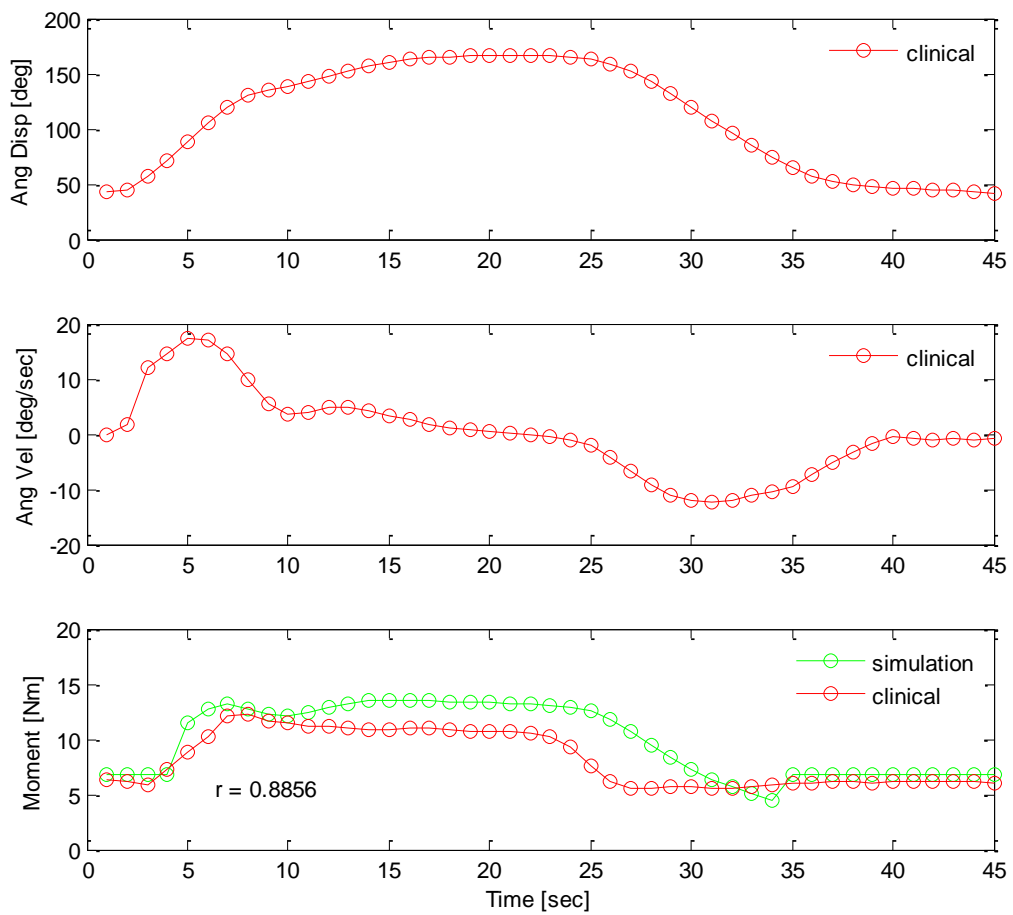

Figure 40 *Simulation results of fast extension MAS1+ spasticity (Patient 10)*

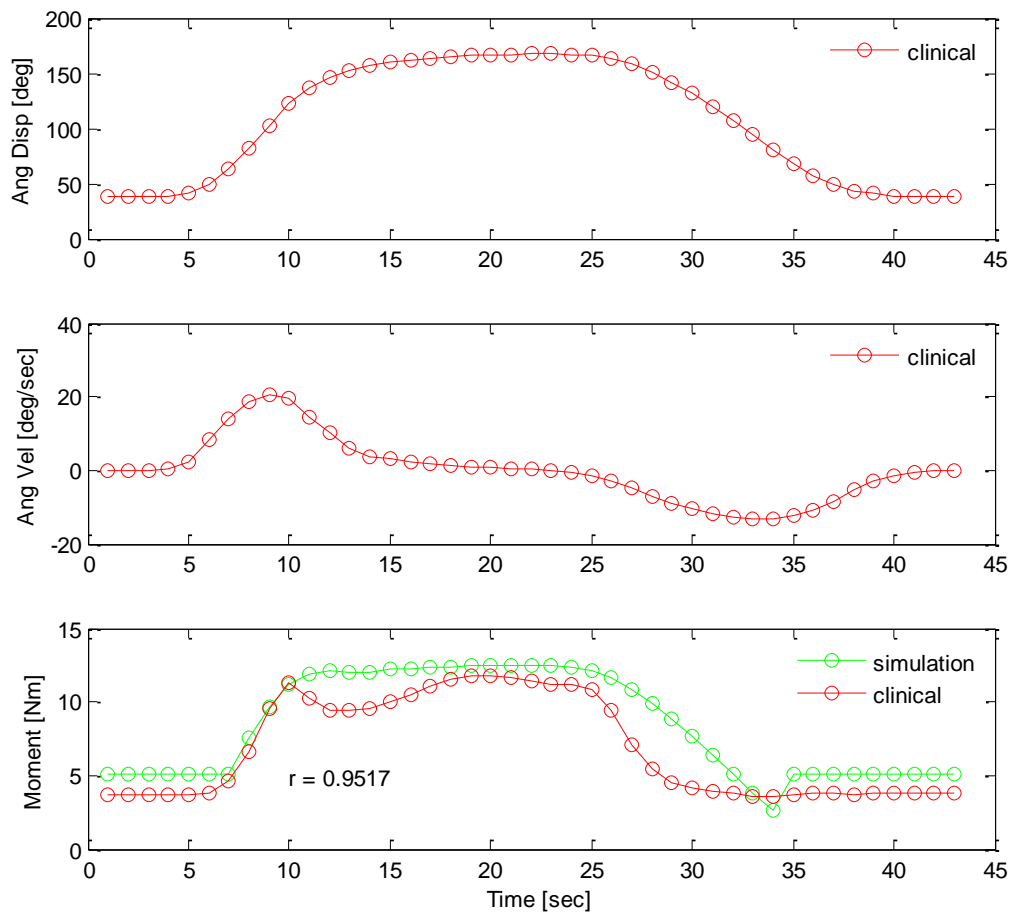

Figure 41 Simulation results of fast extension MAS1+ spasticity (Patient 14)

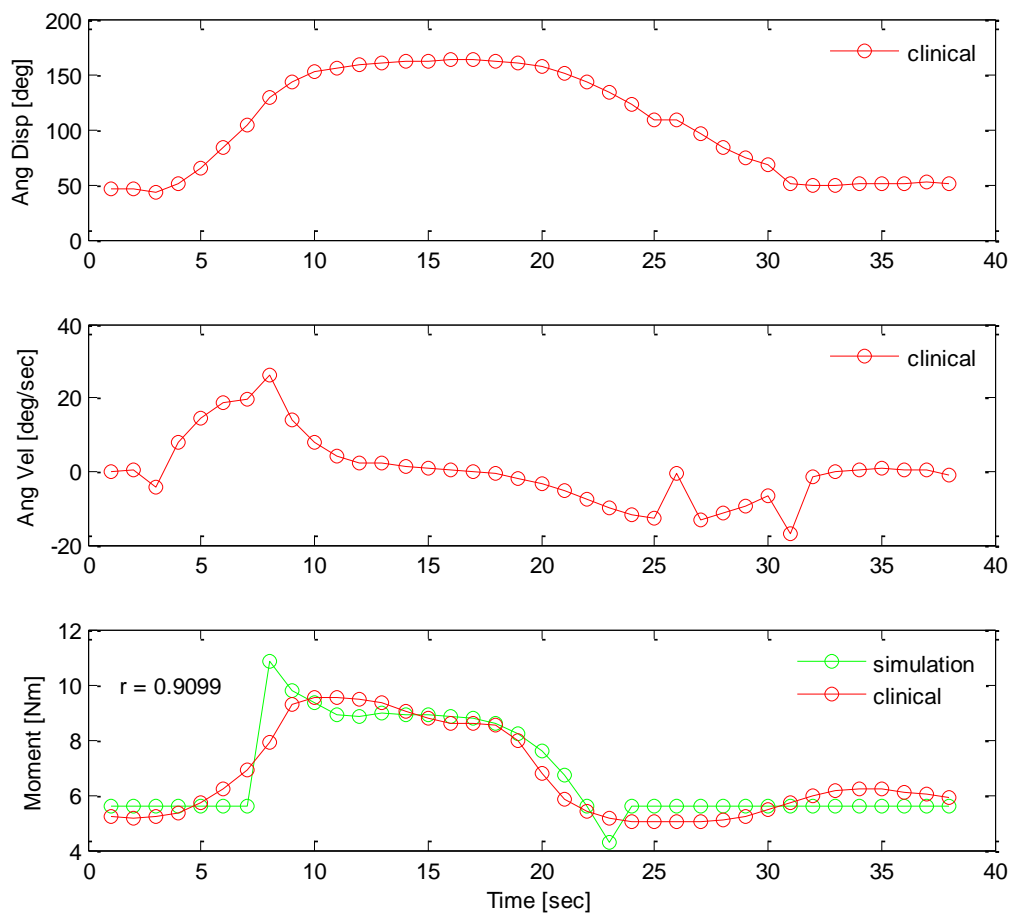

Figure 42 *Simulation results of fast extension MAS1+ spasticity (Patient 15)*

7.3 Discussions

This spasticity model was used to develop a mathematical model of spasticity stiffness and recreate spasticity characteristics during fast stretching speeds of the prototype. As described in the previous section, current parameters were focused on patients diagnosed as MAS 1+ level. Despite the lack of subjects, the developed mathematical model has shown precise spasticity modelling with strong positive linear correlations r for fast stretch condition. Further analysis shall be conducted on the slow stretch condition as well. Later improvements are needed on the neural network

programming language for better application results as the output T from Eq. (2) and (3) when calculated for prototype in real time.

CHAPTER 8

PROTOTYPE DEVELOPMENT

Following the initial shape discussed in CHAPTER 5, the configuration of the system prototype is illustrated in Figure 43. This chapter describes more details on the hardware system and the software system that have been built with reference to the model-based system previously designed.

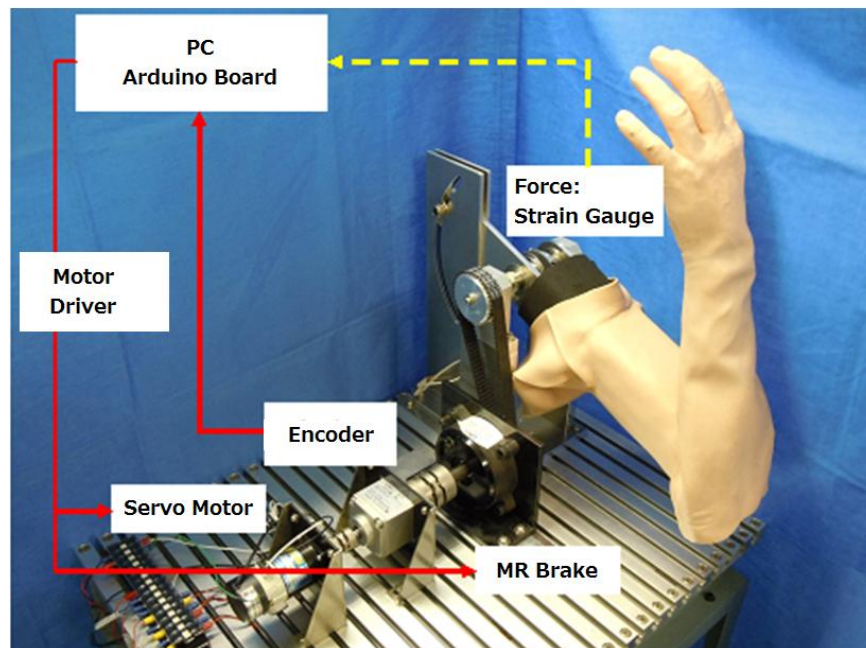

Figure 43 *Actuator and sensor configuration for upper limb spasticity part-task trainer*

8.1 Hardware System

The passive force at the elbow joint is produced by the Magneto-Rheological brake and the DC servo motor is used to transmit force to the elbow joint using a belt and pulley as a cantilever mechanism to provide resistance following the symptoms of the upper limb disorder. A strain gauge is placed at the shoulder shaft to detect the force exerted by the simulator for the purposes of evaluation analysis.

For data acquisition, incremental encoder MG-20-100Z-05 with 100[ppr] has been used to detect angle and angular velocity. Figure 44 shows incremental encoder or quadrature encoder attached to the DC servo motor.

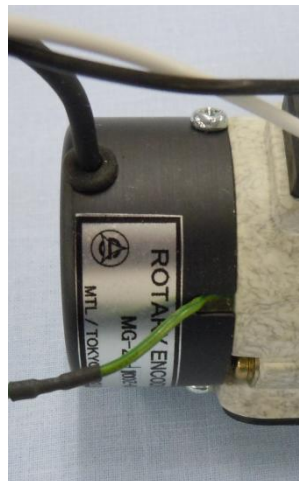

Figure 44 *The incremental encoder for angle and angular velocity data acquisition sensor*

The prototype is using Arduino Mega ADK, as shown in Figure 45, an open-sourced electronic platform allowing to creating interactive electronic programming as the controller system. It can be connected with USB connection with 5[V] power source. Arduino Mega ADK uses Arduino Software (IDE) which is based from the C language.

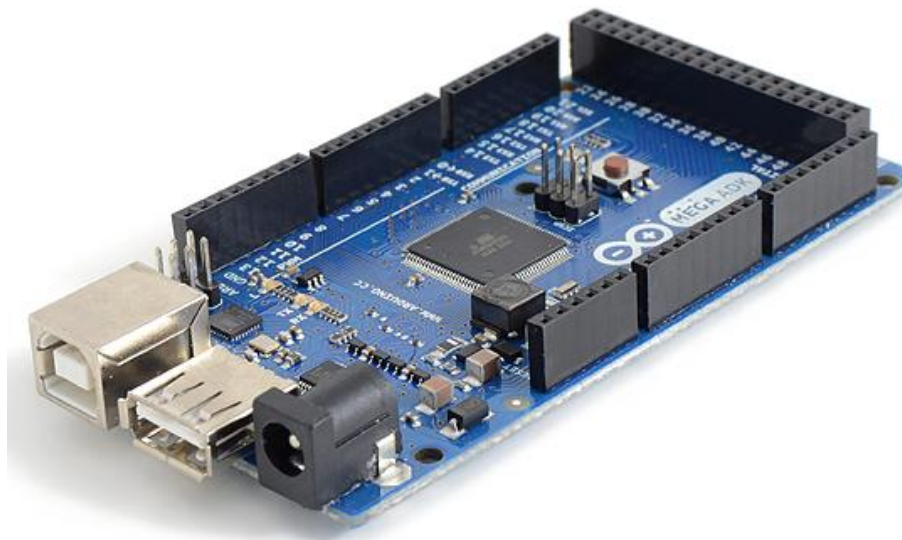

Figure 45 Arduino Mega 2560 Controller

Technical Summary

Microcontroller	ATmega2560
Operating Voltage	5V
Input Voltage (recommended)	7-12V
Input Voltage (limits)	6-20V
Digital I/O Pins	54 (of which 15 provide PWM output)
Analog Input Pins	16
DC Current per I/O Pin	40 mA
DC Current for 3.3V Pin	50 mA
Flash Memory	256 KB of which 8 KB used by bootloader
SRAM	8 KB
EEPROM	4 KB
Clock Speed	16 MHz
USB Host Chip	MAX3421E
Length	101.52 mm
Width	53.3 mm
Weight	36 g

The system is using DC Motor Driver 2x15A Lite in Figure 46 to connect the Arduino Mega ADK to the DC Servo Motor and the Magneto-Rheological Brake. It has two PWM output pins with input voltage of 4.8 - 35 Volts.

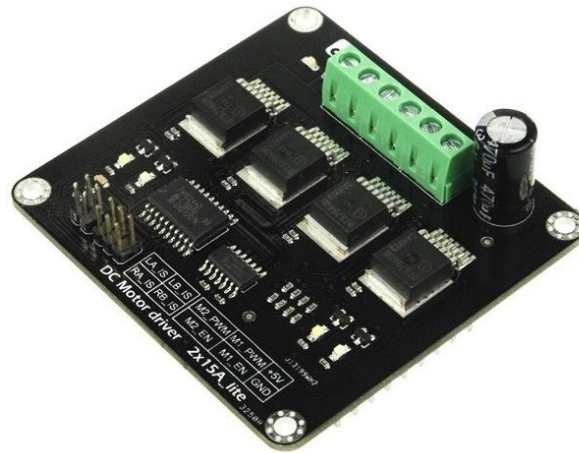
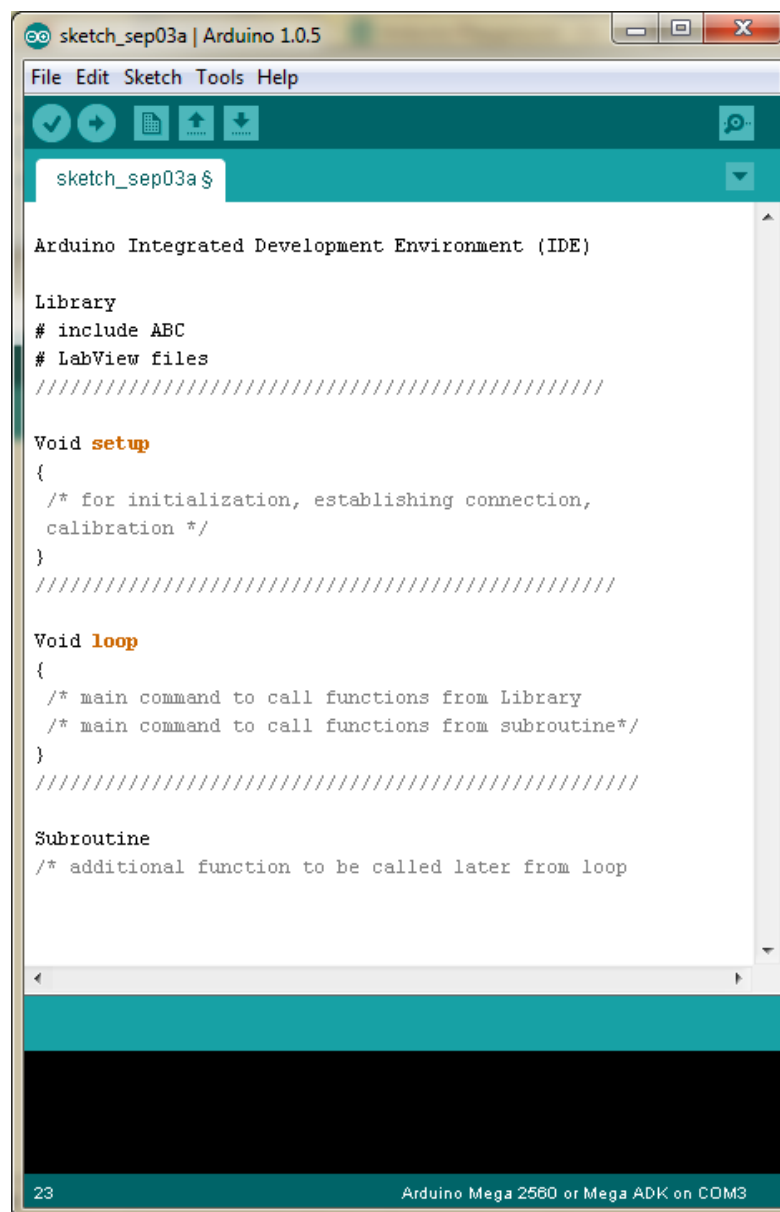

Figure 46 DC Motor Driver 2X15A Lite with 2 PWM output pins

8.2 Software System

Arduino program ver. 1.0.1 is used in computing the program system. It is divided into three parts; structure, values of variables and constants and functions. The program written with Arduino IDE is called sketches. Arduino sketches consist of Library, void setup, void loop and subroutine as explained in Figure 47. Arduino language is basically a compilation of C/C++ language which is from the code written in Arduino program.



```
sketch_sep03a | Arduino 1.0.5
File Edit Sketch Tools Help
sketch_sep03a $
Arduino Integrated Development Environment (IDE)
Library
# include ABC
# LabView files
////////////////////////////////////

Void setup
{
  /* for initialization, establishing connection,
  calibration */
}
////////////////////////////////////

Void loop
{
  /* main command to call functions from Library
  /* main command to call functions from subroutine*/
}
////////////////////////////////////

Subroutine
/* additional function to be called later from loop

23 Arduino Mega 2560 or Mega ADK on COM3
```

Figure 47 *Arduino IDE software structure*

For the temporary Graphical User Interface (GUI), a microcontroller data acquisition add-on tool for Microsoft Excel called **Parallax Data Acquisition tool (PLX-DAQ)** was applied. The tool can allow any connection from any microcontrollers to the PC serial port to plot graph in real-time using Microsoft Excel. Additional code is needed in Arduino program to connect PLX-DAQ tool. The GUI is shown in Figure 48.

The results obtain was analysed using **MATLAB ver. R2013a**, a computing language tool to get better data visualization. MATLAB is a programming language developed by MathWorks which allows data manipulations, plotting of functions, data and interfacing programs written in other languages as well.

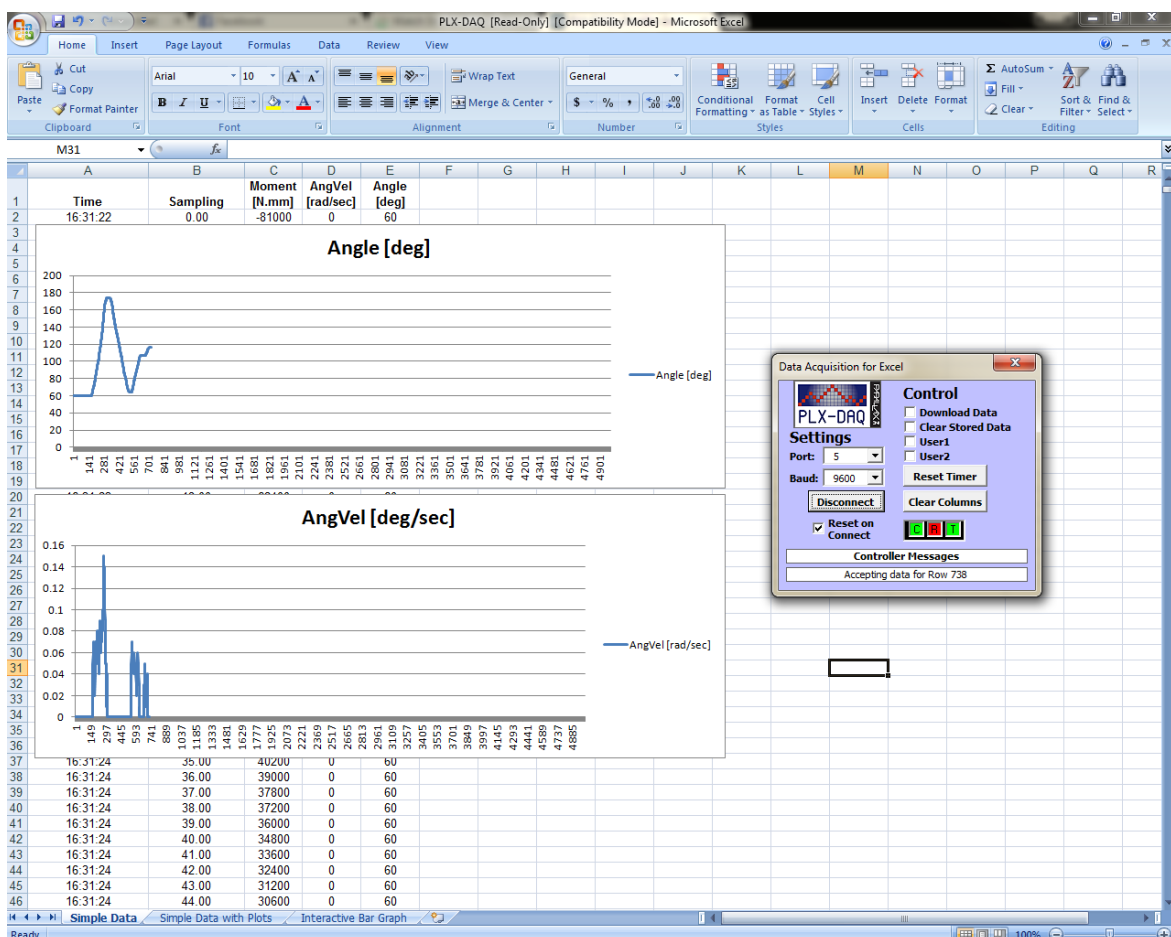

Figure 48 Add-in Microsoft Excel GUI Parallax Data Acquisition (PLX-DAQ) tool

8.3 Evaluation Experiment Set-up

Instead of using a full arm prototype for the system integration's evaluation, as shown in Figure 43, a dummy prototype using application scenario of Case A as in **Figure 18 Application A: Slow stretch haptic feedback for all MAS level**, for slow stretch haptic feedback and Case C as in **Figure 20 Application C: MAS 1+ fast stretch haptic feedback p1** and **Figure 21 Application C: MAS 1+ fast stretch haptic feedback p2**, for fast stretch haptic feedback in MAS 1+ has been conducted.

The evaluations following the fast and slow stretch assessments were based from MTS assessment measured using a built-in strain gauge module [SEN77631Y3] which used the 350 Ω strain gauge BF350-3AA as in Figure 49. The strain gauge module was placed at the dummy arm as in Figure 50 and shows details of dummy arm setup to conduct programming system evaluation, while Figure 51 shows our first evaluation experiment with the help of the rehabilitation physician. However, the initial experiment has been suspended due to the safety factors.



Figure 49 *The Strain gauge module [SEN77631Y3]*

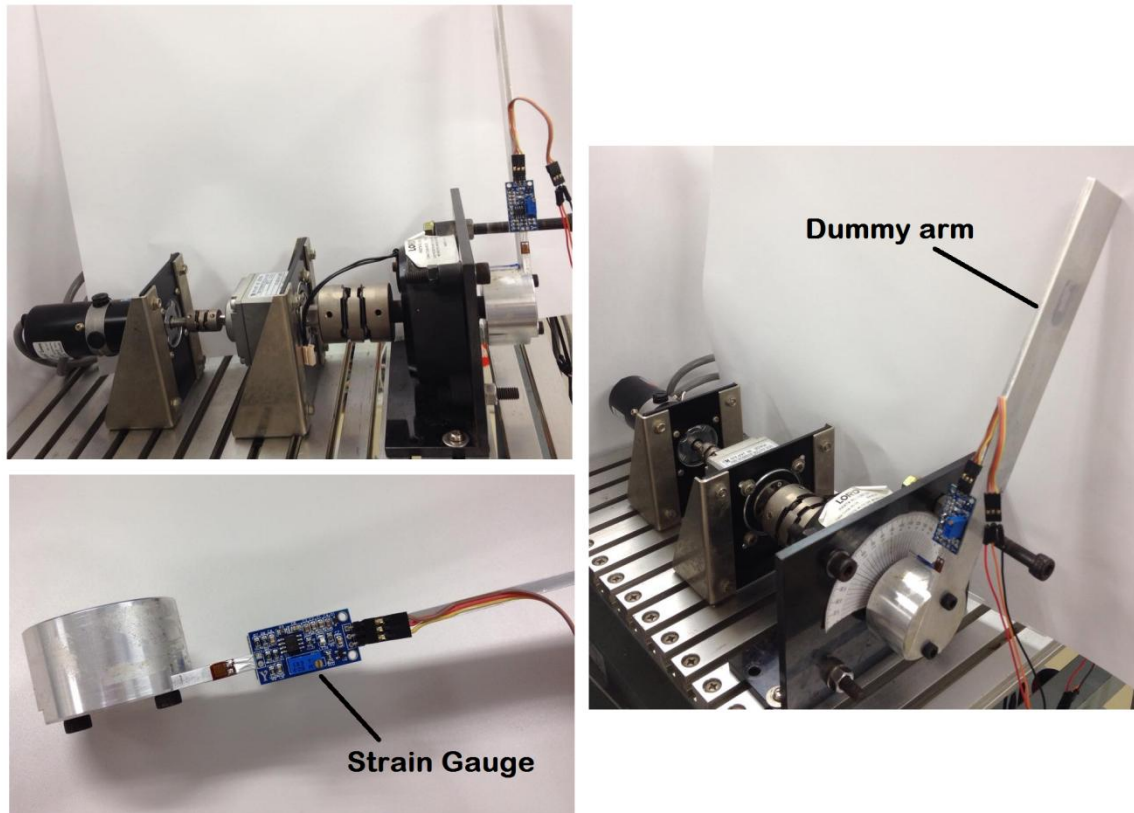

Figure 50 *Dummy arm prototype used to evaluate the programming system*



Figure 51 *Illustration of dummy prototype evaluation by experience physician*

8.4 Evaluation Results

The experiment was later conducted without the presence of the experienced rehabilitation physician. Figure 52 and Figure 53 show the results from CASE A; Slow Stretch Haptic Feedback evaluation. The evaluation demonstrates that full ROM was at 176 [deg] and 172 [deg] with average moment around 2 [Nm] to 2.5 [Nm], respectively. The results verify that the encoder control system programming's flowchart in CASE A was operating smoothly where muscle catch does not occur to the dummy prototype when angular velocity is less than 10 [deg/sec]. However, the strain gauge module detected a moment of inertia during the first stretch movement for both trials.

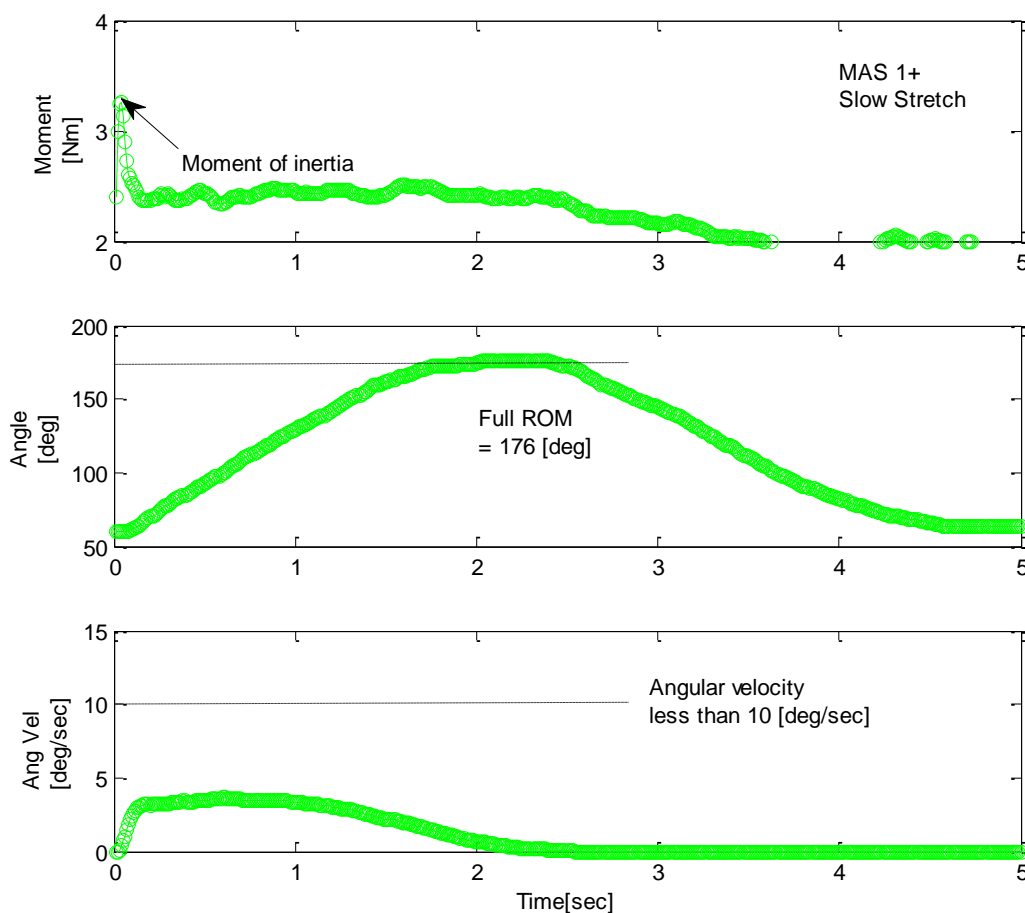

Figure 52 *Prototype results of slow stretch MAS1+ spasticity 1st Trial*

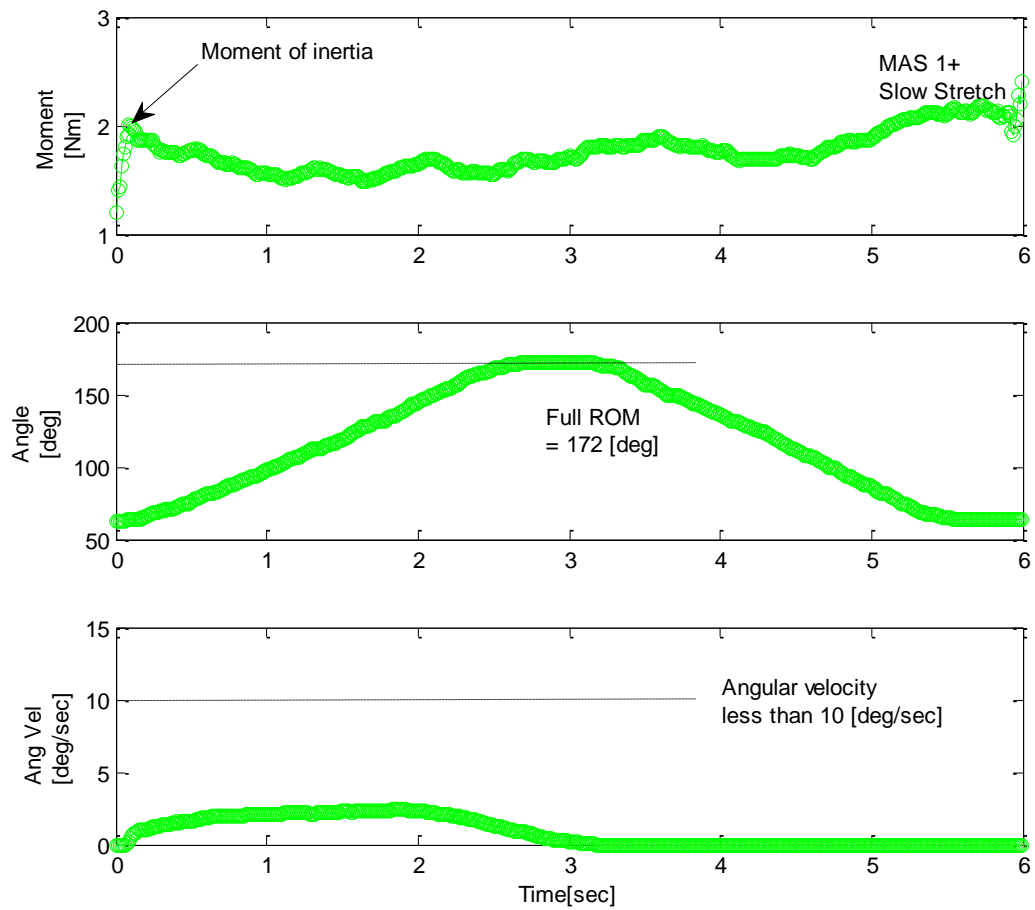

Figure 53 *Prototype results of slow stretch MAS1+ spasticity 2nd Trial*

Evaluation on CASE C; Fast Stretch Haptic Feedback MAS 1+ provides results as shown in Figure 54 and Figure 55. Similar with CASE A, the results prove that the control system is well developed for actuators and encoder closed loop feedback, where the system was able to detect angle and angular velocity, while sending signal to the actuators in real time. Muscle catch position was detected at 152 [deg] and 109 [deg], respectively. However, the moment of inertia shows that larger moment was detected compared to the resistance given during muscle catch. Furthermore, unstable force detection has been recorded at the end of the fully flexion movement in Figure 55.

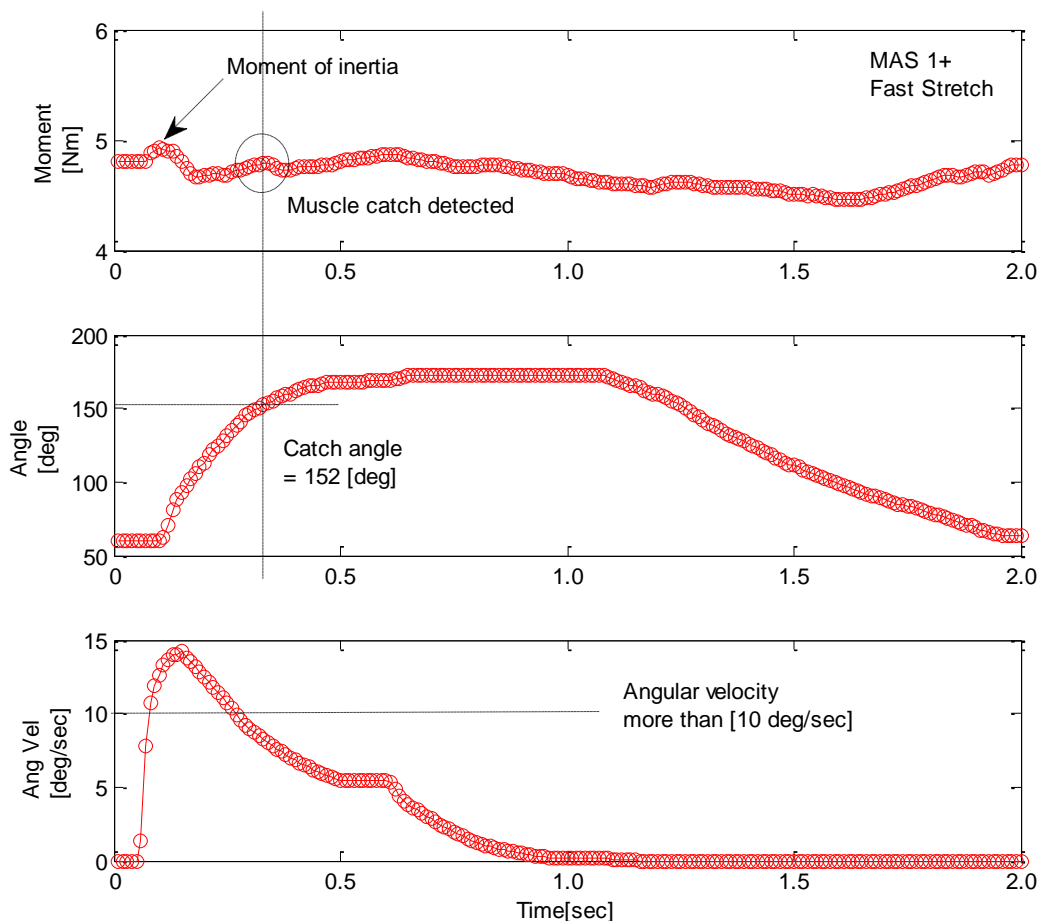

Figure 54 Prototype results of fast stretch MAS1+ spasticity 1st Trial

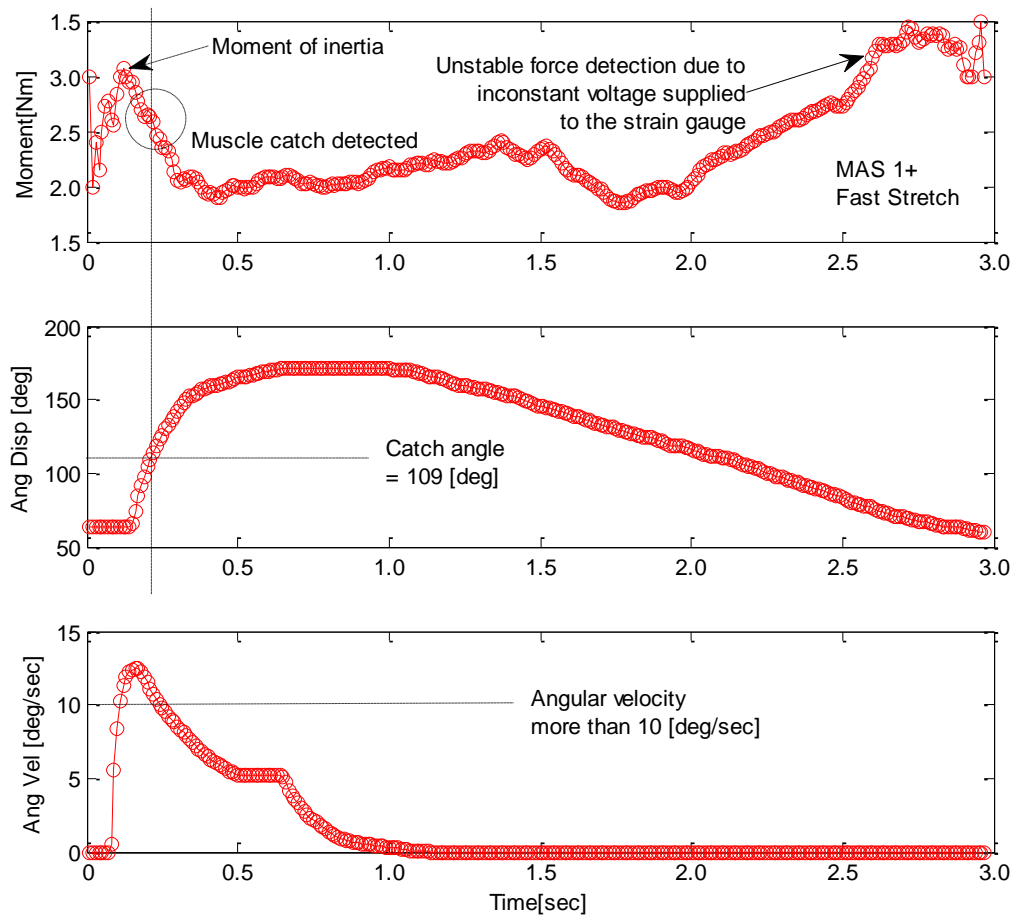

Figure 55 Prototype results of fast stretch MAS1+ spasticity 2nd Trial

8.5 Discussions

The objective of this evaluation is to test if the capability of hardware and software systems can be integrated and emulate spasticity symptoms. Based on the results, two large possibilities have aroused;

1. Evaluation measurement setup

i. Instability of Strain Gauge Module as measurement device

Strain Gauge Module [SEN 77631Y3] was an innovation from Elecrow, an open hardware facilitation company based in Shenzhen, China. The product was first sold recently in July 2015. To reduce the complicated usage of bridges and amplifier setup, a mini size controller board with a 350 Ω strain gauge was built together. Due to their first trial in market, the product would probably have problems in stability and robustness in measuring the strain. Thus producing low repeatability data and higher noise.

ii. Evaluation without a physician/therapist presence

The evaluation was conducted without the presence of a physician or therapist. We were not able to fully identify the successfulness of the spasticity emulation. In order to have the evaluation from physician and therapist, a better programming system with fail safe function is needed to avoid any fatality while conducting the evaluation.

2. Hardware & Software suitability

i. Motor driver

Besides the incompleteness of the programming system, another main problem with the hardware system which leads to the cancellation and inability to conduct evaluation experiments with a physician/therapist, is the instability of DC Motor Driver 2x15A Lite. Theoretically, the motor driver is capable to

handle a 3.0A servo motor (maximum output current: 15A). Additionally, it is also embedded with short circuit, overheating and over-voltage protection. However, over-voltage current occurred during switching on the motor power source resulted in motor started to move and jerking, ignoring standby position instructions from the controller.

ii. MR brake capability evaluation

From clinical data results in section **6.3 Clinical Data Results**, muscle catch occurred with catch moment ± 10 [Nm], however in evaluation trials, the catch moment shows results with only 3~5 [Nm]. By referring to the value itself, the torque produce by MR brake is not enough. Before coming to any conclusion with the actuator's capability, it is important to have evaluation conducted under the supervision of a physician or therapist, as it might actually have resulted from the Strain Gauge Module's performance instead of the MR brake performance itself.

CHAPTER 9

CONCLUSION AND RECOMMENDATION

9.1 Summary

From the literature review chapter, previous research related to the development of a human arm simulator has been thoroughly reviewed. Even though a few works have been done in developing a human arm simulator, there is still some space for improvement and to explore. All research related to upper limb training devices were last published in 2012 and no progress or implementations have been reported after that. Therefore, it is important to continue our research and pioneer this field.

The most important part in developing an upper limb simulator is to have concrete clinical database to later develop into a simulation modelling. Before conducting any research method, a questionnaire-based survey was conducted regarding the opinion of stakeholders involved in therapy education. Our survey was the first to be conducted regarding the opinion of stakeholders involved in therapy education. This survey shall be a trigger in a new paradigm shift of therapy curricular itself.

Subsequent to the survey's results, as a direction for the development, a specification technique of CONSENS™ was applied to guide different disciplinary of

collaborators in this research to reach the same goal. The specification technique CONSENS™ synergizes Value Driven Design and Front End Product Development via the description of a holistic system. The approach helps in enabling effective communications across the domains of medicine, engineering, business and community from the early phases of system development. The technique also helps to avoid overlooking any voice of customer, business and technology and thus satisfying stakeholders' needs.

The analysis discussed in this report demonstrate the difficulties encountered in implementing the specification technique CONSENS™ to develop an upper limb spasticity part-task trainer for the clinical education system. In overall, four main objectives described in *Chapter 1* of this doctoral thesis have been fulfilled. An ethics approval has been granted from the Universiti Teknologi MARA Ethics Committee and a set of spasticity clinical database focusing on the region of Malaysia has been collected. Its characteristics have been analysed and have shown significant patterns of different level of spasticity based on Modified Ashworth Scale assessment though improvement can still be made in the measurement method for better data reliability. The measurement method sustained the idea from other researchers regarding probability in measuring spasticity in quantitative method such as in [71-73] to support conventional assessment method.

From the collected spasticity clinical data, a mathematical modelling was successfully developed. The linear correlation coefficient r shows moderate to strong correlation in emulating spasticity characteristics of MAS level 1+. However, higher levels of mathematical and programming details are needed to completely replicating the spasticity patterns.

A part-task trainer prototype which is able to simulate human upper limb postural movement of arm flexion and extension was developed. Furthermore, the prototype is able to move in pronation and supination of the radius bone, and also the ability to simulate wrist extension with the design of cam shaped elbow joint. Despite the completion of the upper limb part-task trainer, the prototype was not able to be integrated with actuators for evaluation of the system integration due to problems arising from the motor driver. In exchange, a dummy prototype was used as a base to evaluate the actuators capability and the programming system.

9.2 Recommendation & Future Work

In materialising the shape of the upper limb following human arm and emulating the spasticity symptoms, we need better information and excellent actuators and data acquisition system. We recommend that:

1. CONSENSTM Partial Model

- Additional behaviour states for each MAS level are needed in explaining details of each spasticity severity, followed by behaviour activities illustrating how the system shall react to each level.

2. Clinical Data Collection

- Based on Table 14 *Number of subjects participated for each MAS level*, we are still having problem in conducting measurements for subjects with MAS 2 and MAS 3 levels. It is suggested to broaden the area of data collection outside Hospital Sungai Buloh towards home rehabilitation subjects. For subjects with MAS 4 level with rigid arm flexion, a measurement using healthy strong subjects may

be conducted which will show the same characteristics when stretched by a clinician.

- Measurement of an additional parameter is suggested, i.e. surface EMG, a new product from MYON AG, a Swiss company, measures surface EMG, applied force and angular motion concurrently shall be considered. The product is estimated to be launched in six months' time.
- An additional quantitative analysis on the spasticity following each severity must be appended to prove that spasticity can be conveyed in quantitative value, thus, the value can be applied into spasticity mathematical modelling at a later time.
- For force sensor, a new sensor needs to be proposed for changing current force sensor which was too thick and large to fit into the palm of physician. Furthermore, the sensor was not able to be fixed with just the velcro strap thus, providing difficulty during measurement sessions. A new force sensor has been considered.

3. Hardware systems

- In avoiding over current to occur in the present motor driver, a more versatile and efficient motor driver is suggested; a Sabertooth dual 12A motor driver from Dimension Engineering Inc. The driver has its own over current and thermal protection system.

Product Specs

Model: Sabertooth 2X12

Specifications: 12A continuous, 25A peak per channel
Up to 24V in

Synchronous regenerative drive
Ultra-sonic switching frequency
Thermal and over current protection
Lithium protection mode

Input modes: Analogue, R/C, simplified serial, packetized serial

Size: 2.3" x 3" x .7"
59 x 75 x 17 mm

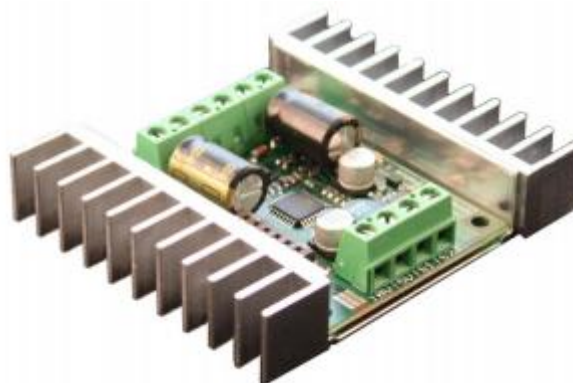

Figure 56 Sabertooth Dual 12A motor driver product by Dimension Engineering Inc.

4. System Evaluation

- A higher level of programming details is needed along with the GUI system to complete the spasticity upper limb part-task trainer and must be evaluated by a clinician before proceeding to the other level related to medical institution official evaluation.

9.3 Conclusions

System engineering was developed since the end of World War II, however it has been slowly improving in methodology since mid-1960s. System engineering is an important measurement of a good project leadership where creating an equal communicating value between different disciplinary research members may reduce cost growth and performance erosion. With the synergisation of CONSENS specification techniques with the Front End Product Development Process for upper limb spasticity part-task trainer, a system communicating value was established into the design team, while simultaneously communicating the design status to the upper management. The approach of this developed design methodology focused on listening to three distinct voices shall be considered as influencers, decision makers and users. The effectiveness of this design methodology shall provide initiatives, insights and solution for project leadership where several field of stakeholders are involved.

Simulation is not a new concept in physiotherapy education. In some form, it has been integrated into many curricula, such as to train basic skills in airway suctioning and lungs. However, there is one limitation that shall be concluded in the development process; part-task trainer or simulator can never replace a patient's position [74]. Therefore the new technology shall enhance the realism of the environment and not just the devices. Moreover, the scope shall not be limited to university education but into professional

training programs as well. Therapy field requires an open mind to this exciting patient simulator and high potential part-task trainer.

REFERENCE

- [1] G. R. J. A D Pandyan, C I M Price, R H Curless, M P Barnes and H Rodgers, "A review of the properties and limitations of the Ashworth and modified Ashworth Scales as measures of spasticity," *Clin Rehabil*, vol. 13, pp. 373–383, 1999.
- [2] R. W. Bohannon and M. B. Smith, "Interrater Reliability of a Modified Ashworth Scale of Muscle Spasticity," *Physical Therapy*, vol. 67, pp. 206-207, February 1, 1987 1987.
- [3] N. J. B. Biering-Sorensen F, Klinge K, "Spasticity-assessment: a review," *Spinal Cord*, vol. 44, pp. 708-722, 2006.
- [4] J. K. Hyung-Soon Park, and Diane L. Damiano, "Development of a Haptic Elbow Spasticity Simulator (HESS) for improving accuracy and reliability of clinical assessment of spasticity.," *IEEE Trans Neural Syst Rehabil Eng.*, vol. 20, pp. 361-370, 2012.
- [5] N. A. C. Zakaria, T. Komeda, C. Y. Low, K. Inoue, and F. A. Hanapiah, "A Questionnaire-Based Survey: Therapist's Response towards the Upper Limb Disorder Learning Tool," in *XII International Science Conference*, Istanbul Turkey, 2014, pp. 1791-1793.
- [6] M. F. Levin, "On the nature and measurement of spasticity," *Clinical Neurophysiology*, vol. 116, pp. 1754-1755, 2005.
- [7] W. W. Gordon JA, Shaffer DW, Armstrong EG, ""Practicing" medicine without risk: students' and educators' responses to high-fidelity patient simulation," *Academic Medicine*, vol. 76, pp. 469-472, 2001.
- [8] W. P. Ziv A, Small SD, Glick S., "Simulation-based medical education: an ethical imperative," *Academic Medicine*, vol. 78, pp. 783-788, 2003.
- [9] "Solving the crisis in clinical education for Australia's health professions: A discussion paper from the Health Professions Council of Australia," Melbourne 2004.
- [10] G. Webb, K.-L. Krause, R. Garnett, and C. R. Grant, "Learning Outcomes and Curriculum Development in Australian Physiotherapy Education," Australian Universities Teaching Committee 2005.
- [11] N. Smith, S. Prybylo, and T. Conner-Kerr, "Using Simulation and Patient Role Play to Teach Electrocardiographic Rhythms to Physical Therapy Students," *Cardiopulmonary Physical Therapy Journal*, vol. 23, pp. 36-42, 2012.
- [12] S. Barry Issenberg, W. C. Mcgaghie, E. R. Petrusa, D. Lee Gordon, and R. J. Scalese, "Features and uses of high-fidelity medical simulations that lead to effective learning: a BEME systematic review," *Medical Teacher*, vol. 27, pp. 10-28, 2005.
- [13] "A Simulator Study of the Interaction of Pilot Workload with Errors, Vigilance, and Decisions.," Washington, DC: National Aeronautics and Space Administration 1979.
- [14] D. J. Fletcher, R. Militello, G. L. Schoeffler, and C. L. Rogers, "Development and evaluation of a high-fidelity canine patient simulator for veterinary clinical training," *Journal of Veterinary Medical Education*, vol. 39 Number 1/2012, pp. 7-12, 2012.
- [15] H. Jeffrey, B. Mordechai, C. Bo, and K. Lawrence, "Incorporation of a computerized human patient simulator in critical care training: a preliminary report.," *Journal of Trauma-Injury Infection & Critical Care*, vol. 53(6), pp. 1064-1067, 2002.
- [16] J. Holcomb, R. Dumire, J. Crommett, C. Stamateris, M. Fagert, J. Cleveland, G. Dorlac, W. Dorlac, J. Bonar, K. Hira, N. Aoki, and K. Mattox, "Evaluation of trauma team performance using an advanced human patient simulator for resuscitation training," *J Trauma*, vol. 52, pp. 1078-1086, 2002.
- [17] H. K. Tetsuya Mouri, Yutaka Nishimoto, Takaaki Aoki, Yasuhiko Ishigure, and Makoto Tanahashi, "Robot Hand Imitating Disabled Person for Education/Training of Rehabilitation," *Journal of Robotics and Mechatronics*, vol. Vol.20, pp. 280-288, 2008.

- [18] T. Kikuchi, K. Oda, and J. Furusho, "Leg-Robot for Demonstration of Spastic Movements of Brain-Injured Patients with Compact Magnetorheological Fluid Clutch," *Advanced Robotics*, vol. 24, pp. 671-686, 2010/01/01 2010.
- [19] G. M. Jensen, J. Gwyer, K. F. Shepard, and L. M. Hack, "Expert Practice in Physical Therapy," *Physical Therapy*, vol. 80, pp. 28-43, 2000.
- [20] C. Physiotherapy, "Report for Physiotherapy," Health Workforce Australia National Simulated Learning Project 2010.
- [21] M. T. Tomohiro Fujisawa, Yoshiyuki Takahashi, Kaoru Inoue, Takafumi Terada, Yukio Kawakami and Takashi Komeda, "Basic Research on the Upper Limb Patient Simulator," in *IEEE 10th International Conference on Rehabilitation Robotics*, Noordwijk, The Netherlands, 2007, pp. 48-51.
- [22] K. T. Takhashi Y, Koyama H, Yamamoto S, Arimatsu T, Kawakami Y, Inoue K, Ito Y., "Development of an upper limb patient simulator for physical therapy exercise.," in *IEEE Int Conf Rehabil Robot.*, ETH Zurich Science City, Switzerland, 2011.
- [23] Y. Takahashi, T. Komeda, H. Koyama, S. I. Yamamoto, T. Arimatsu, Y. Kawakami, and K. Inoue, "Development of a patient simulator for physical therapy exercise of the upper limb," in *Mechatronics (MECATRONICS) , 2012 9th France-Japan & 7th Europe-Asia Congress on and Research and Education in Mechatronics (REM), 2012 13th Int'l Workshop on*, 2012, pp. 391-396.
- [24] K. Jonghyun, P. Hyung-Soon, and D. L. Damiano, "Accuracy and reliability of haptic spasticity assessment using HESS (Haptic Elbow Spasticity Simulator)," in *Engineering in Medicine and Biology Society, EMBC, 2011 Annual International Conference of the IEEE*, 2011, pp. 8527-8530.
- [25] D. I. Grow, W. Mengnan, M. J. Locastro, S. K. Arora, A. J. Bastian, and A. M. Okamura, "Haptic Simulation of Elbow Joint Spasticity," in *Haptic interfaces for virtual environment and teleoperator systems, 2008. haptics 2008. symposium on*, 2008, pp. 475-476.
- [26] T. Mouri, H. Kawasaki, Y. Nishimoto, T. Aoki, and Y. Ishigure, "Development of robot hand for therapist education/training on rehabilitation," in *Intelligent Robots and Systems, 2007. IROS 2007. IEEE/RSJ International Conference on*, San Diego, CA, USA, 2007, pp. 2295-2300.
- [27] (April 2015). *PART 820 -- QUALITY SYSTEM REGULATION 21CFR820.30*. Available: <http://www.accessdata.fda.gov/scripts/cdrh/cfdocs/cfcfr/cfrsearch.cfm?fr=820.30>
- [28] U. S. FDA. (1997). *Design Control Guidance for Medical Device Manufacturers*. Available: <http://www.fda.gov/RegulatoryInformation/Guidances/ucm070627.htm>
- [29] P. H. Paul Collopy, "Value-Driven Design," in *9th AIAA Aviation Technology, Integration, and Operations Conference (ATIO)*, Hilton Head, South Carolina, 2009, pp. 1-16.
- [30] B. D. Lee and C. J. J. Paredis, "A Conceptual Framework for Value-driven Design and Systems Engineering," *Procedia CIRP*, vol. 21, pp. 10-17, 2014.
- [31] U. K. de Ana FJ, Phillips GJ, Conner CP., "Value driven innovation in medical device design: a process for balancing stakeholder voices.," *Annals of Biomedical Engineering*, vol. 41, pp. 1811-1821, 2013.
- [32] U. S. FDA. (2010). *What does it mean for FDA to "classify" a medical device?* Available: <http://www.fda.gov/AboutFDA/Transparency/Basics/ucm194438.htm>
- [33] J. M. D. Consulting. (2014). *Japan's Classification of Medical Devices*. Available: <https://www.j-mdc.com/classification.html>
- [34] D. A. Neumann, *Kinesiology of the Musculoskeletal System – Foundation for Physical Rehabilitation*: Mosby, Inc., 2002.
- [35] NASAM. (April 2015). *Stroke in Malaysia*. Available: http://www.nasam.org/english/prevention-what_is_a_stroke.php

- [36] M. H. D. Woo, P. Sekar, B. Kissela, J. Khoury, A. Schneider, D. Kleindorfer, J. Szaflarski, A. Pancioli, E. Jauch, C. Moomaw, L. Sauerbeck, J. Gebel, and J. Broderick, "Effect of untreated hypertension on hemorrhagic stroke," *Stroke*, vol. 35, pp. 1703-1708, 2004.
- [37] W. H. Rankings. (May 2014). *Health Profile : Japan*. Available: <http://www.worldlifeexpectancy.com/country-health-profile/japan>
- [38] W. H. Rankings. (May 2014). *Health Profile : Malaysia*. Available: <http://www.worldlifeexpectancy.com/country-health-profile/malaysia>
- [39] H. Markus, "Stroke: causes and clinical features," *Medicine (Baltimore)*, vol. 40, pp. 484-489, 2012.
- [40] E. Cardoso, B. Rodrigues, R. Lucena, I. R. D. Oliveira, G. Pedreira, and A. Melo, "Botulinum toxin type a for the treatment of the upper limb spasticity after stroke: A meta-analysis," *Arq. Neuropsiquiatr.*, vol. 63, pp. 30-33, 2005.
- [41] V. Sparkes, "Physiotherapy for Stroke Rehabilitation: A need for evidence-based handling techniques," *Physiotherapy*, vol. 86, pp. 348-356, 2000.
- [42] R. H. Parry, N. B. Lincoln, and M. A. Appleyard, "Physiotherapy for the Arm and Hand after Stroke," *Physiotherapy*, vol. 85, pp. 417-425, 1999.
- [43] S. H. Pierson, "Outcome Measures in Spasticity Management " *Muscle & Nerve*, vol. Supplement 6, pp. S1-S25, 1997.
- [44] R. L. Sloan, E. Sinclair, J. Thompson, S. Taylor, and B. Pentland, "Inter-rater reliability of the modified Ashworth Scale for spasticity in hemiplegic patients," *Int J Rehabil Res*, vol. 15, pp. 158-61, 1992.
- [45] W. K. L. Yam and M. S. M. Leung, "Interrater Reliability of Modified Ashworth Scale and Modified Tardieu Scale in Children With Spastic Cerebral Palsy," *Journal of Child Neurology*, vol. 21, pp. 1031-1035, 2006.
- [46] A. Mutlu, A. Livanelioglu, and M. K. Gunel, "Reliability of Ashworth and Modified Ashworth Scales in Children with Spastic Cerebral Palsy," *BMC Musculoskeletal Disorders*, vol. 9, 2008.
- [47] T. Kaya, A. Goksel Karatepe, R. Gunaydin, A. Koc, and U. Altundal Ercan, "Inter-rater reliability of the Modified Ashworth Scale and modified Modified Ashworth Scale in assessing poststroke elbow flexor spasticity," *International Journal of Rehabilitation Research*, vol. 34, pp. 59-64 10.1097/MRR.0b013e32833d6cdf, 2011.
- [48] K. W. Jan Mehrholz, Daniel Meißner, Kay Grundmann, Christian Zange, Rainer Koch, Marcus Pohl, "Reliability of the Modified Tardieu Scale and the Modified Ashworth Scale in adult patients with severe brain injury: a comparison study," *Clinical Rehabilitation*, vol. 19, pp. 751-759, 2005.
- [49] A. Fosang, M. Galea, A. McCoy, D. Reddihough, and I. Story, "Measures of muscle and joint performance in the lower limb of children with cerebral palsy," *Developmental Medicine and Child Neurology*, vol. 45, pp. 664-670, 2003.
- [50] P. Singh, A. Joshua, S. Ganeshan, and S. Suresh, "Intra-rater reliability of the modified Tardieu scale to quantify spasticity in elbow flexors and ankle plantar flexors in adult stroke subjects," *Ann Indian Acad Neurol*, vol. 14, pp. 23-26, 2011.
- [51] W. D. Paulis, H. L. D. Horemans, B. S. Brouwer, and H. J. Stam, "Excellent test-retest and inter-rater reliability for Tardieu Scale measurements with inertial sensors in elbow flexors of stroke patients," *Gait & Posture*, vol. 33, pp. 185-189, 2011.
- [52] J. Gausemeier, L. Cheng Yee, D. Steffen, and S. Deyter, "Specifying the Principle Solution in Mechatronic Development Enterprises," in *Systems Conference, 2008 2nd Annual IEEE*, 2008, pp. 1-7.
- [53] F. J. R. Jürgen Gausemeier, Wilhelm Schäfer, *Design Methodology for Intelligent Technical Systems: Develop Intelligent Technical Systems of the Future*: Springer Science & Business Media, 2014.

- [54] N. A. Che Zakaria, C. Y. Low, F. A. Hanapiah, T. Komeda, K. Inoue, M. S. Shazidi, and H. M. Hamsan, "Evaluation of Upper Limb Spasticity towards the Development of a High Fidelity Part-task Trainer," *Procedia Technology*, vol. 15, pp. 818-827, 2014.
- [55] C. Z. Noor Ayuni, T. Komeda, L. Cheng Yee, and K. Inoue, "Emulation of muscle tone of upper limb spasticity and rigidity," in *6th International IEEE/EMBS Conference on Neural Engineering (NER), 2013* San Diego, CA, 2013, pp. 1590-1593.
- [56] A. Naaji, "Working Space Representation for the Human Upper Limb in Motion," in *7th WSEAS Int. Conf. on Applied Computer & Applied Computational Science (ACACOS '08)*, Hangzhou, China., 2008, pp. 394-399.
- [57] M. A. A. K. Cheng Yee Low, Torben Koch, Roman Dumitrescu, Hanafiah Yussof, Roseleena Jaafar, Ahmed Jaffar, Ahsana Aqilah and Kok Mun Ng, "Hybrid-Actuated Finger Prosthesis with Tactile Sensing," *International Journal of Advanced Robotic Systems*, vol. 10, pp. 1-10, 2013.
- [58] E. P. Solomon, *Introduction to Human Anatomy and Physiology*, 2nd ed.: Saunders, 2003.
- [59] K. Karakoc, E. J. Park, and A. Suleman, "Design considerations for an automotive magnetorheological brake," *Mechatronics*, vol. 18, pp. 434-447, 2008.
- [60] J. Furusho, T. Kikuchi, M. Tokuda, T. Kakehashi, K. Ikeda, S. Morimoto, Y. Hashimoto, H. Tomiyama, A. Nakagawa, and Y. Akazawa, "Development of Shear Type Compact MR Brake for the Intelligent Ankle-Foot Orthosis and Its Control; Research and Development in NEDO for Practical Application of Human Support Robot," in *Rehabilitation Robotics, 2007. ICORR 2007. IEEE 10th International Conference on*, 2007, pp. 89-94.
- [61] H. Naito, Y. Akazawa, K. Tagaya, T. Matsumoto, and M. Tanaka, "An ankle-foot orthosis with a variable-resistance ankle joint using a magnetorheological-fluid rotary damper," *Journal of Biomechanical Science and Engineering*, vol. 4, pp. 182-191, 2009.
- [62] D. MacAuley. (2013). *Oxford Handbook of Sport and Exercise Medicine (Second ed.)*.
- [63] P. Singh, A. M. Joshua, S. Ganeshan, and S. Suresh, "Intra-rater reliability of the modified Tardieu scale to quantify spasticity in elbow flexors and ankle plantar flexors in adult stroke subjects," *Annals of Indian Academy of Neurology*, vol. 14, pp. 23-26, Jan-Mar 2011.
- [64] J. Gäverth, M. Sandgren, P. Lindberg, H. Forssberg, and A. Eliasson, "Test-retest and inter-rater reliability of a method to measure wrist and finger spasticity," *J Rehabil Med.*, vol. 45, pp. 630-636, 2013.
- [65] N. Clopton, J. Dutton, T. Featherston, A. Grigsby, J. Mobley, and J. Melvin, "Interrater and intrarater reliability of the Modified Ashworth Scale in children with hypertononia," *Pediatr Phys Ther.*, vol. 17, pp. 268-274, 2005 Winter.
- [66] S.-H. Schless, K. Desloovere, E. Aertbeliën, G. Molenaers, C. Huenaearts, and L. Bar-On, "The Intra- and Inter-Rater Reliability of an Instrumented Spasticity Assessment in Children with Cerebral Palsy," *PLoS One*, vol. 10, pp. 1-23, 2015.
- [67] K. P. G. Ann E. Tuzson, Mark F. Abel, "Spastic Velocity Threshold Constrains Functional Performance in Cerebral Palsy," *Arch Phys Med Rehabil*, vol. 84, pp. 1363-1368, 2003.
- [68] M. S. Annaswamy T, Allison SC, Abraham LD., "Measurement of Plantarflexor Spasticity in Traumatic Brain Injury," *Am J Phys Med Rehabil*, vol. 86, pp. 404-411, 2007.
- [69] D. L. Damiano, J. M. Quinlivan, B. F. Owen, P. Payne, K. C. Nelson, and M. F. Abel, "What does the Ashworth scale really measure and are instrumented measures more valid and precise?," *Developmental Medicine & Child Neurology*, vol. 44, pp. 112-118, 2002.
- [70] S. O. Shun Ishikawa, Kaoru Isogai, Yasuhiro Akiyama, Naomi Yanagihara, Yoji Yamada, "Wearable Dummy to Simulate Joint Impairment: Severity-based Assessment of Simulated Spasticity of Knee Joint," in *Proceedings of the 2013 IEEE/SICE International Symposium on System Integration*, Kobe, Japan, 2013, pp. 300-305.

-
- [71] A. D. Pandyan, C. I. M. Price, H. Rodgers, M. P. Barnes, and G. R. Johnson, "Biomechanical examination of a commonly used measure of spasticity," *Clinical Biomechanics*, vol. 16, pp. 859-865, 2001.
- [72] A. Calota, A. G. Feldman, and M. F. Levin, "Spasticity measurement based on tonic stretch reflex threshold in stroke using a portable device," *Clinical Neurophysiology*, vol. 119, pp. 2329-2337, 2008.
- [73] Y.-N. Wu, Y. Ren, A. Goldsmith, D. Gaebler, S. Q. Liu, and L.-Q. Zhang, "Characterization of spasticity in cerebral palsy: dependence of catch angle on velocity," *Developmental Medicine & Child Neurology*, vol. 52, pp. 563-569, 2010.
- [74] B. Flanagan, D. Nestel, and M. Joseph, "Making patient safety the focus: crisis resource management in the undergraduate curriculum," *Medical Education*, vol. 38, pp. 56-66, 2004.

APPENDICES

APPENDIX A
(QUESTIONNAIRE-BASED SURVEY)

No age



平成 25 年 6 月
芝浦工業大学大学院 理工学研究科
博士後期課程 1 年 ノールアユニ
指導教員 米田隆志

理学療法士・作業療法士の教育に対するアンケートの願い

拝啓 平素は格別のご高配を賜り、厚く御礼申し上げます。

私ども芝浦工業大学米田研究室では、かねてより教育のための上肢疾患用患者シミュレータの開発を行ってまいりました。今回その一環として理学療法士・作業療法士の講義・実習または教育流れへの上肢疾患用患者シミュレータの適切な活用に関する研究を企画しております。

そこで理学療法士・作業療法士教員または理学療法士・作業療法士卒業生(大学院生)からのご意見やリクエストに関するアンケート調査実施したく、突然で失礼ではありますが、ご協力をお願いをさせて頂きました。このアンケートを完了するには約 10 分必要となります。ご回答ただけでしたら、私宛のメール<nb13104@shibaura-it.ac.jp>に送信して頂きますようお願いいたします。

ご回答頂いた内容は、今後の上肢疾患用患者シミュレータの開発のあり方の示唆を与える資料として、また基本資料として活用して頂きたいと考えています。

なお、内容について芝浦工業大学、首都大学東京及びマレーシアのマラ工科大学で学術的な目的のみに使用させていただきます。

ご多忙中に恐縮ではございますが、ご協力いただきますようよろしくお願い申し上げます。

敬具

連絡先： ノールアユニ
nb13104@shibaura-it.ac.jp

年齢 :
教育経験年数(ありの方) : 年(years)

1. 現在の理学療法士・作業療法士の教育には基礎マネキン、学生同士または教員相手、及び模擬患者の練習を利用しています。これらの教育の手法をすべて行うことは病院実習で学生が実際の患者を扱う前の事前訓練として十分であると思いますか。
 - a. 思う
 - b. どちらかといえば思う
 - c. どちらかといえば思わない
 - d. 思わない
2. 学生の教育を基礎マネキン、学生同士または教員相手、及び模擬患者の練習を利用した訓練だけにした場合、臨床実習で実際の患者に施す際に患者を危険にさらす可能性があると思いますか。
 - a. 思う
 - b. どちらかといえば思う
 - c. どちらかといえば思わない
 - d. 思わない
3. 「基礎マネキン、学生同士または教員相手、及び模擬患者」のどちらかの練習を利用した上で、まだ療法士の間ではまたは療法士自身の判断にばらつきがあると思いますか。
 - a. 思う
 - b. どちらかといえば思う
 - c. どちらかといえば思わない
 - d. 思わない
4. 現在行われている教育において理学療法士・作業療法士を目指す学生は臨床実習を行うためにより多くの練習回数が必要だと思いますか。
 - a. 思う
 - b. どちらかといえば思う
 - c. どちらかといえば思わない
 - d. 思わない

次の質問を下記の説明を読んでお答えください。

芝浦工業大学では理学療法士・作業療法士教育用の患者シミュレータを開発しています(図1, 図2参照)。この患者シミュレータは上肢疾患用の患者シミュレータで痙性または固縮疾患の症状を再現するものです。この患者シミュレータは Modified Ashworth Scale によって繰り返し同じ重症度の症状を再現できるため学生の評価能力を高めることができ、療法士の間でも重症度のばらつき問題の解決ができるのではないかと考えます。ただし、現在のシステムでは関節の動きの症状を再現できただけで筋肉や骨の動き・感触はシミュレータで再現していません。



図1. 上肢疾患用患者シミュレータ



図2. 上肢疾患用患者シミュレータを使う様子

この患者シミュレータを用いて患者へのリスクを下げるために、新たな教育の流れを提案することを考えています。今考えている流れはまず学生同士・教員相手の練習あるいは模擬患者による訓練によって腕を動かした際の健常な筋肉や骨の動き・感触を学び、その後患者シミュレータの練習によって上肢疾患の抵抗および症状を発生した腕の動きを学ぶことができます。その後、健常のお年寄りとの対話でコミュニケーションスキルあるいはマナーを身につけることができると考えています。

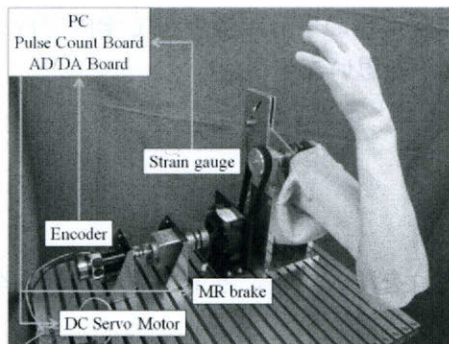
「患者シミュレータと新たな教育の流れ」の提案に関してお答えください。

4. 上述した提案を臨床実習の事前訓練として貴校の講義・実習または臨床実習で役立つと思いますか。
 - a. 思う
 - b. どちらかといえば思う
 - c. どちらかといえば思わない
 - d. 思わない
5. 上述したシミュレータまたは教育流れを貴校で使用してみたいと思いますか。
 - a. 思う
 - b. どちらかといえば思う
 - c. どちらかといえば思わない
 - d. 思わない
6. 5 番の質問に対してなぜそう答えたか、またはもし活用できると思う方はどのような講義で活用したいと思いますか。

痙性や固縮を体験するには適していると思う。評価の基準についても一定で経験することがメリットであるが、学生に経験・学習して欲しい関節は肩や股関節といった問題が多くアプローチ頻度高い個所である。そのため、肘関節に限局され、かつ筋緊張が触診できず一定の運動方向のみであるのならば対費用効果が大きな懸念材料である。また、リスク管理の面では筋緊張が亢進しているよりも低下し必要以上に関節へストレスをかけることが問題となるため、抵抗感が強いことに関しては大きな問題となることが少ないと考える。

7. このような患者シミュレータを使用する上で臨床実習の事前訓練として学内で行う練習回数または学生の自習時間を増やすことができますか。

- a. 思う
- b. どちらかといえば思う
- c. どちらかといえば思わない
- d. 思わない

8. このような患者シミュレータと新しい教育の流れを導入することで、患者への安全性を高めることができますか。

- a. 思う
- b. どちらかといえば思う
- c. どちらかといえば思わない
- d. 思わない

それはなぜですか。

概ね6番で説明した内容のため。

9. このようなシミュレータと新しい教育の流れを導入すると療法士の評価能力を高め、ばらつきを下げることができますか。

- a. 思う
- b. どちらかといえば思う
- c. どちらかといえば思わない
- d. 思わない

10. 提案した患者シミュレータまたは新しい教育の流れに関してのご意見をお書きください。

アメリカの大学教育に取り入れられているような、シュミレーションラボのマネキンに取り入れられたら素晴らしいと思います。

Age 26



芝浦工業大学
SHIBAURA INSTITUTE OF TECHNOLOGY



首都大学東京
TOKYO METROPOLITAN UNIVERSITY

Survey on Physiotherapist and Occupational Therapist Training

Date: June 2013

Dear Participant:

My name is Noor Ayuni Che Zakaria and I am a graduate student at Shibaura Institute of Technology, Japan. For my doctoral project, I am developing an upper limb part-task trainer for the therapists education purpose. Because you are involved in the therapists education either as an educator or as the graduate student from the therapists education system, I am inviting you to participate in this research study by completing the attached surveys. This surveys is based on the Japan and Malaysia therapists education.

The following questionnaire will require approximately 15 minutes to complete. There is no compensation for responding nor is there any known risk. In order to ensure that all information will remain confidential, please do not include your name and your institution. Copies of the project will be provided to my Shibaura Institute of Technology supervisor and to our collaborator, my co-supervisor from Universiti Teknologi MARA, Faculty of Mechanical Engineering. If you choose to participate in this project, please answer all questions as honestly as possible and return the completed questionnaires promptly by replying to this email address <ayuni.uitm@yahoo.com>. Participation is strictly voluntary and you may refuse to participate at any time.

Thank you for taking the time to assist me in my educational endeavors. The data collected will provide some inputs from the end users in order to better understand the requirements for developing a part-task trainer for therapists education. I would like to know whether the therapists actually agree with the idea of using simulators in the therapists clinical training, and what are their expectations. With such inputs, my institution and collaborators hope the development of the system can be oriented towards meeting the needs of the customers. Completion and return of the questionnaire will indicate your willingness to participate in this study. If you require additional information or have questions, please contact me at the number listed below.

Sincerely,

NOOR AYUNI BINTI CHE ZAKARIA

+8180-4922-3101 or <ayuni.uitm@yahoo.com>

PROF. TAKASHI KOMEDA

+8148-720-6018 or <komeda@se.shibaura-it.ac.jp>

Age : 26 years

Teaching Experience : (6 months) years (if instructor)

1. Current education of physiotherapists and occupational therapist training is applying low fidelity mannequins, role-play training between students or faculty physician and simulated patients. Current training method (might differ in different country) is enough before the students engage with real patients during their clinical training.
 - a. strongly agree
 - b. agree
 - c. disagree
 - d. strongly disagree

2. Using method of low fidelity mannequins, role-play training between students or faculty physician and simulated patients, the students will risking the patients safety during their clinical training.
 - a. strongly agree
 - b. agree
 - c. disagree
 - d. strongly disagree

3. Despite of using current methods such as low fidelity mannequins, role-play training between students or faculty physician and simulated patients, we still have variable rating of patients symptoms severity between the therapists and within the therapist himself/herself.
 - a. strongly agree
 - b. agree
 - c. disagree
 - d. strongly disagree

4. Students require higher frequency of training before engage with the real patient during their clinical training?
 - a. strongly agree
 - b. agree
 - c. disagree
 - d. strongly disagree

Please answer the next questions based on the suggested new syllabus explain below.

In Shibaura Institute of Technology, Japan, we are developing a part-task trainer for the education purpose of the physiotherapist and occupational therapist student (refer to Fig. 1 and Fig. 2). The simulator is focusing on the upper limb disorder. The simulator is able to reproduce the symptoms of spasticity and rigidity such as the movement and resistance giving by the patients, consistently. By repeatedly simulate different levels of severity, this might improve the students learning rating the patients symptoms level of based on Modified Ashworth Scale and suggesting the proper treatment

schedule. We also hope this will reduce the variability of ratings between raters and within raters. Current progress, the patient simulator is still not able to reproduce the muscle and the anatomy movement.

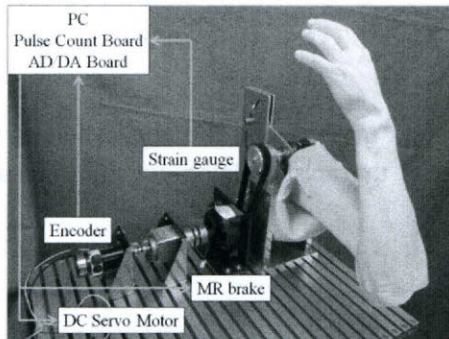

Fig. 1 Image of Patient Simulator of Upper Limb Disorder under development



Fig. 2 Illustration on how to use the upper limb disorder patient simulator

Apart from improving the therapist rating ability, we have highly hope with the application of simulator, we are able to avoid risking patient during clinical training. A new education method including the application of patient simulator has been suggested to increase the therapists capability. First, students learn touch feeling of muscle and anatomy from the role-play training between students or faculty physician or simulated patients depends on your current institution methods. Next the student can increase the frequency of training and engage with various symptoms and level of severity using patient simulator. They can learn communication skills, manner and ethics through clinical training with healthy old people before having clinical training with the patients.

5. Based on the explanation above, the suggested education method and the patient simulator application can be implemented in the physiotherapists and occupational therapist training.
 - a. strongly agree
 - b. agree
 - c. disagree
 - d. strongly disagree

6. I am interested in applying the suggested education method and patient simulator in my department/university?
 - a. strongly agree
 - b. agree
 - c. disagree
 - d. strongly disagree

Why you said so in question No. 5.

Might be useful for undergraduate students to experience different of muscle strengths and other components that related before conduct or applying assessment or therapy to patients/clients.

7. With the implementation of a patient simulator, the new training method could provide higher frequency of training for the students.
 - a. strongly agree
 - b. agree
 - c. disagree
 - d. strongly disagree

8. With the implementation of the suggested education method and the application of patient simulator into the physiotherapist and occupational therapist training, we can increase the patient safety during clinical training.
 - a. strongly agree
 - b. agree
 - c. disagree
 - d. strongly disagree

Why you said so in Question No. 8.

So that future students have some ideas on to which degree/level the applied therapy can be done to the patients/clients instead of referring to some fake facial expression from clients/patients. Clients/patients sometime saying differently from what they experienced while doing their therapy session.

9. With the implementation of the suggested education method and the application of patient simulator, we can increase the therapists rating ability and reduce the ratings variability.
 - a. strongly agree
 - b. agree
 - c. disagree
 - d. strongly disagree

10. Please write your suggestion or comment regarding the suggested education method and the patient simulator.

In the future, the simulator might be able to demonstrate and represent for different age level, form child to adult. I believe, this simulator was generally for patient who experienced stroke at later stage, which at the stage of hypertone. But it might be useful if it can simulate for muscle at the level of hypotone. Other kind of condition such as cerebral palsy, down syndrome, global developmental delay and etc., this simulator might be a useful method for future students to learn and experience such different level of muscle tone for the children.

END OF SURVEY FORM

APPENDIX B
(ETHICS APPLICATION DOCUMENTS)



Tarikh : 26 November 2013

Dr. Khalid Ibrahim
Pengarah
Hospital Sungai Buloh
47000 Sungai Buloh
Selangor.

Tuan Pengarah

MEMOHON KEBENARAN MENJALANKAN KAJIAN DI HOSPITAL SUNGAI BULOH

Dengan segala hormatnya saya merujuk kepada perkara di atas.

2. Saya sebagaimana nama dan alamat di atas ingin memohon kebenaran menjalankan kajian bertajuk Penciptaan Alat Latihan Simulasi Klinikal untuk Spastisiti dan Ketegangan Bahagian Anggota Lengan dan Tangan di Hospital Sungai Buloh. Kajian ini bertujuan untuk menilai ciri-ciri kerosakan anggota lengan dan tangan menggunakan goniometer dalam pengukuran sendi siku dan meter kekuatan otot sewaktu sesi rehabilitasi. Ini adalah untuk membina pangkalan data gejala-gejala asas spastisiti dan ketegangan (lead-pipe dan cogwheel) untuk tujuan merekabentuk alat latihan simulasi klinikal.

3. Saya telah pun mendaftar kajian ini dengan NMRR dan nombor kajian saya ialah **18681**. Berikut dilampirkan sekali cadangan penyelidikan untuk rujukan pihak tuan. Diharap permohonan ini mendapat pertimbangan tuan.

Segala kerjasama dan perhatian yang diberikan amatlah dihargai.

Sekian, terima kasih.

Yang benar,

Dr.-Ing. Low Cheng Yee
Ketua Pusat Kecemerlangan
Humanoid Robot and Bio-sensing HuRoBs

Pejabat Am/General Office
Tel: 03 5544 5191/5190/5162 Faks: 03 5543 5160

Timbalan Dekan (Akademik)

Deputy Dean (Academic)

Tel: 03 5543 5150

Timbalan Dekan (Hal Ehwal Pelajar)

Deputy Dean (Student Affairs & Alumni)

Tel: 03 5543 5133

Timbalan Dekan (Penyelidikan & Jaringan Industri)

Deputy Dean (Research & Industrial Networking)

Tel: 03 5543 5218

Timbalan Pendaftar

Deputy Registrar

Tel: 03 5544 2842

Penolong Pendaftar (Pentadbiran Am, Kualiti, Penyelidikan dan Jaringan Industri)

Assistant Registrar (General Administration, Quality, Research and Industrial Networking)

Tel: 03 5543 5188

Penolong Pendaftar (Akademik, Pelajar & Alumni)

Assistant Registrar (Academic, Students & Alumni)

Tel: 03 5543 5176

E-mail: ar_fme@salam.uitm.edu.my

Pegawai Eksekutif

Executive Officer

Tel: 03 5543 5190/5142/5143/5164/5191/5189/5162

E-mail: eo_fme@salam.uitm.edu.my



ISO 9001 : 2008 Cert. No. 404071

Reference : 600-RMI (5/1/6)
Date : 30 October 2013

Dr. Low Cheng Yee
Faculty of Mechanical Engineering
Universiti Teknologi MARA
40450 Shah Alam
Selangor

Dear Dr. Low Cheng Yee,

ETHICS APPROVAL BY UiTM RESEARCH ETHICS COMMITTEE - Development of a Part-Task Trainer for Upper Limb Spasticity

Thank you for your research ethics application and presentation on 22 October 2013. With pleasure we would like to inform that the UiTM Research Ethics Committee had deliberated your proposal.

The REC members attending the above meeting are shown below:

Name	REC Membership	Designation
Professor Dato' Dr. Abu Bakar Abdul Majeed	Chairman of UiTM Research Ethics Committee	Assistant Vice Chancellor (Research) Professor, Faculty of Pharmacy, UiTM
Professor Dato' Dr. Khalid Yusoff	Deputy Chairman	Vice Chancellor & President, UCSI University, Malaysia.
Dato' Mohamed Dahan Abdul Latif	Member	Chairman, Flight Solutions Sdn. Bhd.
Professor Dr. Nafeeza Mohd Ismail	Member	Dean, Faculty of Medicine, UiTM
Professor Dr. Mohamed Ibrahim Abu Hassan	Member	Dean, Faculty of Dentistry, UiTM
Professor Dr. Zainuddin Merican Md Hashim Merican	Member	Professor, College University Medical Science (Pharmacology)
Datin Dr. Hj Sarina Md Yusoff	Member	Head of Postgraduate Studies, Faculty of Sport Science and Recreation, UiTM
Dr. Fadilah Abd Rahman	Member	Lecturer, Academy of Contemporary Islamic Studies, UiTM
Dr. Zainal Abidin Abdul Majeed	Member	Head, Integriti Premier Malaysia
Dr. Sh. Mohd Saifuddeen Sh. Mohd Salleh	Member	Consultant, Academy of Islamic Studies, University of Malaya
Dr. Zulkiflee Abd Latif	Secretary	Fellow, Research Management Institute, UiTM

We hereto agreed to grant the Research Ethics approval for the said study.

Thank you.

Yours truly



PROFESSOR DATO' DR ABU BAKAR ABDUL MAJEED
Assistant Vice Chancellor (Research)
Chairman of UiTM Research Ethics Committee

c.c.: Dean
Faculty of Sport Science and Recreation
Universiti Teknologi MARA
40450 Shah Alam
Selangor



JAWATANKUASA ETIKA & PENYELIDIKAN PERUBATAN
(Medical Research & Ethics Committee)
KEMENTERIAN KESIHATAN MALAYSIA
d/a Institut Pengurusan Kesihatan
Jalan Rumah Sakit, Bangsar
59000 Kuala Lumpur

Tel. : 03 2282 9082/03 2282 9085
03 2287 4032/03 2282 0491
Faks : 03 2287 4030

Ruj. Kami : (4) KKM/NIHSEC/P14-87
Tarikh : 24hb Februari 2014

Low Cheng Yee
Faculty of Mechanical Engineering, UiTM
University Teknologi Mara
40450 Shah Alam

Tuan/Puan

NMRR-13-1384-18681 (IIR)

Development of a Part-Task Trainer for Upper Limb Spasticity

Lokasi Projek : Hospital Sungai Buloh

Dengan hormatnya perkara di atas adalah dirujuk.

2. Jawatankuasa Etika & Penyelidikan Perubatan (JEPP), Kementerian Kesihatan Malaysia (KKM) tiada halangan dari segi etika ke atas pelaksanaan kajian tersebut. JEPP mengambil maklum bahawa kajian tersebut tidak mempunyai intervensi klinikal ke atas subjek dan hanya melibatkan pengumpulan data melalui menggunakan goniometer dan meter kekuatan otot untuk mengukur sudut sendi siku dan daya yang dikenakan oleh ahli terapi sewaktu sesi rehabilitasi sahaja.

3. Segala rekod dan data adalah **SULIT** dan hanya digunakan untuk tujuan kajian ini dan semua isu serta prosedur mengenai **data confidentiality** mesti dipatuhi. Kebenaran daripada Pengarah Hospital di mana kajian akan dijalankan mesti diperolehi terlebih dahulu sebelum kajian dijalankan. Tuan/Puan perlu akur dan mematuhi keputusan tersebut.

4. Adalah dimaklumkan bahawa kelulusan ini adalah sah sehingga 24hb Februari 2015. Tuan/Puan perlu menghantar 'Continuing Review Form' (Lampiran 1) selewat-lewatnya 2 bulan sebelum tamat tempoh kelulusan ini bagi memperbaharui kelulusan etika.

Pihak Tuan/Puan juga perlu mengemukakan laporan tamat kajian pada penghujung kajian ini dan juga laporan mengenai "All adverse events, both serious and unexpected" kepada Jawatankuasa Etika & Penyelidikan Perubatan, KKM jika berkenaan.

Sekian terima kasih.

BERKHIDMAT UNTUK NEGARA

Saya yang menurut perintah,

DATO' DR CHANG KIAN MENG

Pengerusi

Jawatankuasa Etika & Penyelidikan Perubatan
Kementerian Kesihatan Malaysia

Continuing Review Form

PROTOCOL NO.	NMRR No.
STUDY TITLE:	
NAME OF PRINCIPAL INVESTIGATOR:	
ACTION REQUESTED: <input type="checkbox"/> Renew – New subjects enrollment to continue <input type="checkbox"/> Renew – Enrolled subjects follow up only <input type="checkbox"/> Terminate – Study discontinued HAVE THERE BEEN ANY AMENDMENTS SINCE THE LAST REVIEW? <input type="checkbox"/> NO <input type="checkbox"/> YES (Describe briefly in attached narrative)	HAS ANY INFORMATION APPEARED IN THE LITERATURE, OR EVOLVED FROM THIS OR SIMILAR RESEARCH THAT MIGHT AFFECT THE MREC'S EVALUATION OF THE RISKS / BENEFITS ANALYSIS OF HUMAN SUBJECTS INVOLVED IN THIS STUDY? <input type="checkbox"/> NO <input type="checkbox"/> YES (Discuss in the attached narrative)
SUMMARY OF STUDY SUBJECTS: <input type="checkbox"/> Enrollment ceiling set by MREC <input type="checkbox"/> New subjects enrolled since last review <input type="checkbox"/> Total subjects enrolled since study started.	HAVE ANY UNEXPECTED COMPLICATIONS OR SIDE EFFECTS BEEN NOTED SINCE LAST REVIEW? <input type="checkbox"/> NO <input type="checkbox"/> YES (Discuss in the attached narrative)
ENROLLMENT EXCLUSIONS <input type="checkbox"/> NONE <input type="checkbox"/> MALE <input type="checkbox"/> FEMALE <input type="checkbox"/> OTHER (specify: _____)	HAVE ANY SUBJECT WITHDRAWN FROM THIS STUDY SINCE THE LAST MREC APPROVAL? <input type="checkbox"/> NO <input type="checkbox"/> YES (Discuss in the attached narrative)
IMPAIRED SUBJECTS <input type="checkbox"/> None <input type="checkbox"/> Physically <input type="checkbox"/> Cognitively <input type="checkbox"/> Both	INVESTIGATIONAL NEW DRUG / DEVICE <input type="checkbox"/> NO <input type="checkbox"/> IND <input type="checkbox"/> IDE FDA Number Name: Sponsor: Holder:
HAVE THERE BEEN ANY CHANGES IN THE SUBJECT POPULATION, RECRUITMENT OR SELECTION CRITERIA SINCE THE LAST REVIEW? <input type="checkbox"/> NO <input type="checkbox"/> YES (Explain changes in attached narrative)	IONIZING RADIATION USE (X-rays, radioisotopes, etc) <input type="checkbox"/> None <input type="checkbox"/> Medically indicated only
HAVE THERE BEEN ANY CHANGES IN THE INFORMED CONSENT PROCESS OR DOCUMENTATION SINCE THE LAST REVIEW? <input type="checkbox"/> NO <input type="checkbox"/> YES (Explain changes in attached narrative)	HAVE ANY CO- / SITE INVESTIGATORS BEEN ADDED OR REMOVED SINCE THE LAST REVIEW? <input type="checkbox"/> NO <input type="checkbox"/> YES (Identify all changes in attached narrative)
HAVE ANY INVESTIGATOR DEVELOPED AN EQUITY OR CONSULTATIVE RELATIONSHIP WITH A SOURCE RELATED TO THIS STUDY WHICH MIGHT BE CONSIDERED A CONFLICT OF INTEREST? <input type="checkbox"/> NO <input type="checkbox"/> YES (Append a statement of disclosure)	HAVE ANY NEW COLLABORATING SITES (INSTITUTIONS) BEEN ADDED OR REMOVED SINCE THE LAST REVIEW? <input type="checkbox"/> NO <input type="checkbox"/> YES (Identify all changes and provide an explanation of changes in attached narrative)

SIGNATURES:

_____ (Principal Investigator)

_____ (Date)

Tarikh : 26 November 2013

Medical Research and Ethics Committee (MREC)

Ministry of Health, Malaysia
NIH Secretariat
d/a Institut Pengurusan Kesihatan
Jalan Rumah Sakit, Bangsar
59000 Kuala Lumpur

Dear Chairman

**APPLICATION FOR ETHICS APPROVAL: DEVELOPMENT OF A PART-TASK
TRAINER FOR UPPER LIMB SPASTICITY**

We are writing to apply for ethics approval in order to conduct the above-mentioned study in Hospital Sungai Buloh.

This study is estimated to begin in December 2013 and will be carried out for 36 months. The investigators involved in this project are as follows:

Name	Institution	Role
Dr.-Ing Low Cheng Yee	Faculty of Mechanical Eng., UiTM Shah Alam	PRINCIPAL INVESTIGATOR
Dr. Fazah Akhtar Hanapiah	Faculty of Medicine, UiTM Sungai Buloh Campus	INVESTIGATOR
Noor Ayuni Che Zakaria	Faculty of Mechanical Eng., UiTM Shah Alam	INVESTIGATOR

Enclosed herewith are:

1. Investigators CV
2. Proposal (Research Protocol)
3. Patient Information Sheet
4. Patient Consent Form
5. UiTM Ethics Approval Letter

Thank you for your kind consideration.

Yours faithfully

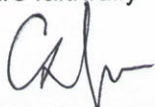

Dr.-Ing. Low Cheng Yee
Principal Investigator

Pejabat Am/General Office
Tel: 03 5544 5191/5190/5162 Faks: 03 5543 5160

Timbalan Dekan (Akademik)

Deputy Dean (Academic)

Tel: 03 5543 5150

Timbalan Dekan (Hal Ehwal Pelajar)

Deputy Dean (Student Affairs & Alumni)

Tel: 03 5543 5133

Timbalan Dekan (Penyelidikan & Jaringan Industri)

Deputy Dean (Research & Industrial Networking)

Tel: 03 5543 5218

Timbalan Pendaftar

Deputy Registrar

Tel: 03 5544 2842

**Penolong Pendaftar (Pentadbiran Am, Kualiti,
Penyelidikan dan Jaringan Industri)**

Assistant Registrar (General Administration, Quality,
Research and Industrial Networking)

Tel: 03 5543 5188

Penolong Pendaftar (Akademik, Pelajar & Alumni)

Assistant Registrar (Academic, Students & Alumni)

Tel: 03 5543 5176

E-mail: ar_fme@salam.uitm.edu.my

Pegawai Eksekutif

Executive Officer

Tel: 03 5543 5190/5142/5143/5164/5191/5189/5162

E-mail: eo_fme@salam.uitm.edu.my



ISO 9001 : 2008 Cert. No. 404071



Borang Permohonan Kelulusan Etika *Application Form for Ethics Approval*

BAHAGIAN A: Maklumat ringkas projek *Part A : Brief Details of Project*

Tajuk Projek : Development of a Part-Task Trainer for Upper Limb
Title of Project : Spasticity

Nama Ketua Projek: _____
Name of Project Leader : Dr.-Ing. Low Cheng Yee

Bidang pengkhususan : _____
Area of Specialisation : Model-based Mechatronic Engineering, Rehabilitation Robotics

Alamat Jabatan dan Hospital/ Institut: _____
Affiliation : Humanoid Robots and Bio-Sensing Center (HuRoBs), Faculty of Mechanical Engineering, Universiti Teknologi MARA, 40450 Shah Alam, Selangor

No Telefon/ E-mail : 03-5543 6276 / 017-960 5568
Contact No/ E-mail : low.uitm@gmail.com
chengyee.low@salam.uitm.edu.my

Nama Ahli Projek: _____
Name of Project Member : Dr.Fazah Akhtar binti Hanapiah

Noor Ayuni binti Che Zakaria

BAHAGIAN B: Protokol Projek *Part B : Project Protocol*

<p>1. 0</p>	<p>Latar belakang: Background (Keterangan ringkas tentang masalah yang dikaji dan penyemakan literatur untuk menyokong keterangan tentang masalah yang dikaji. Sila lampirkan sekiranya ruang tidak mencukupi) <i>A brief explanation of the problem to be studied and literature review to support. Please append if more space is required.</i></p> <p>Simulators have been used in educating young pilots to fly airplanes safely for decades [1], and recently used to assist veterinary clinical training [2] as well as medical education [3][4]. Teaching and learning in clinical field is challenging as it deals with real patients of human or animal. In order to avoid injuries or fatal occurrences, a simulator can be used for practice until the students master the required clinical skills.</p> <p>A simulator that can provide complete human physiological response is called a patient simulator [5]. A patient simulator is normally a computer-controlled human mannequin that is able to function as human anatomy and react to clinical procedures used in training medical doctors, surgeons, nurses or therapists. On the other hand, a part-task trainer is a segment of human body simulator and emulates specific situations in order to help the trainees learn new clinical skills.</p> <p>Current patient simulators are used in clinical training to upgrade performances and skills in surgery [6] or anesthesia. It has been proven that human patient simulator is able to develop good performance of a medical team even in complex field such as trauma resuscitation [7]. This is due to the fact that the usage of a patient simulator encourages the team to practice high risk skills in a risk free environment.</p> <p>However, for physiotherapist training, the trainees still have to engage directly with patients to get experience and build up confidence. High-fidelity human patient simulators customized for physiotherapy training are nonexistent. In order to be an expert in physical therapy, therapists need to have multidimensional knowledge base where one of the concepts of therapy skills is the use of touch [8].</p> <p>Health Workforce Australia National Simulated Learning Project reported that fifteen of the sixteen universities frequently use simulated learning program (SLP) during their pre-clinical programs often focus on role playing/peer learning, e-learning and low fidelity mannequins. This elaborate the importance of using simulation to help young therapist practitioners gain experience thus lead to the needs of high fidelity patient simulator or part-task trainer that can provide different patient cases and the opportunity to have contact with 'patient' in a safe and encouraging environment [9].</p> <p>In this study, we focus on developing an artificial upper limb of a human adult for pre-clinical training of physiotherapists and occupational therapists. For this purpose, clinical data of upper limb disorders must be collected and a database concerning haptic movement has to be developed.</p> <p>This ethics application document shall be the platform in fundamental investigation of the characteristics of upper limb disorder focusing on spasticity symptoms and the implementation of robot simulator in the therapist education system as a training tool. The outcome of this analysis will contribute to current and future research on upper limb disorder, particularly for therapist education.</p> <p>Rujukan: Reference</p> <p>[1] Ruffell-Smith HP. A Simulator Study of the Interaction of Pilot Workload with Errors, Vigilance, and Decisions. <i>Washington, DC: National Aeronautics and Space Administration</i>, 1979 p1–54.</p>
-----------------	---

	<p>[2] Daniel J. Fletcher, Roberta Militello, Gretchen L. Schoeffler, Catherine L. Rogers. Development and Evaluation of a High-Fidelity Canine Patient Simulator for Veterinary Clinical Training. <i>Journal of Veterinary Medical Education</i> Volume 39, Number 1 /2012 pp 7-12.</p> <p>[3] Smith N, Prybylo S, Conner-Kerr T. Using human patient simulation (HPS) and standardized patients (SP) to teach electrocardiographic (ECG) rhythms: Student perceptions of learning experiences. <i>Cardiopulm Phys Ther J.</i> 2011;22(4):28</p> <p>[4] Issenberg B, Mcgaghie WC, Petrusa ER, Lee Gordon D, Scalese RJ. Features and uses of high-fidelity medical simulations that lead to effective learning: A BEME systematic review. <i>Med Teach.</i>2005;27(1):10–28.</p> <p>[5] Felicity C Blackstock, Gwendolen A Jull. High-fidelity patient simulation in physiotherapy education. <i>Australian Journal of Physiotherapy</i> 2007 vol. 53 pp. 3-5</p> <p>[6] Hammond, Jeffrey MD, MPH; Bermann, Mordechai MD; Chen, Bo MS; Kushins, Lawrence MD. Incorporation of a Computerized Human Patient Simulator in Critical Care Training: A Preliminary Report. <i>Journal of Trauma-Injury Infection & Critical Care:</i> December 2002 Volume 53(6) pp 1064-1067</p> <p>[7] John B. Holcomb, MD, Russell D. Dumire, MD, et al. " Evaluation of Trauma Team Performance Using an Advanced Human Patient Simulator for Resuscitation Training ". <i>J Trauma.</i> 2002;52:1078 –1086.</p> <p>[8] Gail M Jensen, Jan Gwyer, Katherine F Shepard, Laurita M Hack. "Expert Practice in Physical Therapy". <i>Phys Ther.</i> 2000; 80:28-43.</p> <p>[9] Felicity C Blackstock, Gwendolen A Jull. "High-fidelity Patient Simulation in Physiotherapy Education". <i>Australian Journal of Physiotherapy</i> 2007 Vol. 53 pp 3-5.</p>
<p>2. 0</p>	<p>Objektif dan Justifikasi Projek Penyelidikan Dijalankan: <i>Objectives and Justifications for the Project to be carried out:</i></p> <p><i>This study embarks on the following objectives:</i></p> <ul style="list-style-type: none"> I. To measure the angular motion and torque characteristics of upper limb spasticity II. To build up a quantitative clinical database for upper limb spasticity specific for the Malaysian community III. To develop a part-task trainer prototype that can emulate upper limb spasticity for therapist education
<p>3. 0</p>	<p>Faedah Yang Dijangka: <i>Expected Benefits:</i></p> <p>a) <i>New findings/Knowledge</i></p> <p>This project will result in new potential towards application of robotics simulator in therapy education. Some of the concepts and novel knowledge acquired from this research will lead to new exploration as follows:</p> <ul style="list-style-type: none"> a) exploration of upper limb disorder characteristics and development of a clinical database for the Malaysia region b) development of a part-task trainer for therapists education c) the therapists perception in using part-task trainer as an alternative clinical training can be evaluated

b) Research Publications/Intellectual Property

- a) At least 1 papers in high impact journals, such as International Journal of Rehabilitation Research, IEEE Transaction on Robotics and International Journal on Social Robotics.
- b) At least 2 conference papers indexed in IEEE/ISI/Scopus such as IEEE Engineering in Medicine & Biology Society Conference, ACM/IEEE International Conference on Human-Robot Interaction and IEEE International Conference on Robotics Systems
- c) Intellectual properties will be filed for devices such as a biomimetic spastic elbow device, a part-task trainer in compliance with the Modified Ashworth Scale and a part-task trainer in compliance with the Tardieu scale

c) Specific or Potential Applications

Patients have the right to receive the best care that can be reasonably provided. It is understood that clinicians-in-training will treat patients; however, from an ethical perspective, harm to patients as a byproduct of training or lack of experience is justified only after maximizing approaches that do not put patients at risk. In the field of rehabilitation, physical therapist plays an important role to resume social life of patients from their diseases or physical handicaps. However, they can only obtain their skills and experience from their practical clinical experiences encountered with patients. New trainees may risk the patients. This proposal focuses on developing a high-fidelity part-task trainer of upper limb spasticity for clinical teaching and learning.

This project will result in a high-fidelity part-task trainer of upper limb spasticity in compliance with the Modified Ashworth Scale and the Tardieu Scale. The part-task trainer allows trainees to practice a psychomotor skill in isolation and practice specific task for the therapy of spasticity. Further, it can allow instructors to validate a skill prior to allowing a novice to perform that skill on a real person. This allows trainees to have their first encounters with real patients when they are at higher levels of technical and clinical proficiency.

This project aims at the market of medical equipments, in particular medical simulator. Indeed, simulation in health care is becoming an essential component of education, training, assessment, and the maintenance of professional certification. In the more recent past, healthcare simulation has progressed as a discipline, and is now becoming a requirement for residency education, board certification, and in some cases for maintenance of certification.

As medical simulation centers are cropping up across the world, developing economies such as Malaysia present ample growth opportunities for health care equipments due to our lower R&D and production costs. Adopting newer technologies for the development of high-fidelity part-task trainers as presented in this proposal has emerged as the most significant trend in the market. This project serves as a stimulus to consolidate a new medical simulation industry, in line with the National Key Economic Areas (NKEA) in healthcare.

The part-task trainer strengthens the confidence and promotes competence of therapists by providing a safe and supportive environment for mastering skills, practicing protocols, and applying critical decision making. The positive impact in terms of improving patient safety, reducing medical errors and decreasing health care costs is far reaching. It can be related to National Key Result Area (NKRA) to raise living standards of low income households by enabling the disabled to participate in economy activities again.

	<p>d) Number of PhD and Masters (by research) Students</p> <p>To train at least one PhD student and one master student. Potential dissertation titles includes:</p> <ul style="list-style-type: none"> a) Development of High Fidelity Part-task Trainer Emulating Upper Limb Disorder for the Therapists Education b) Systems Thinking Based on A Domain-Spanning Principle Solution in Synergizing the Conceptual Design Of Rehabilitation Engineering Systems
<p>4.0</p>	<p>Jangkamasa Projek: <i>Timeframe of the Project :</i></p> <p>Duration: <u>36 Months</u> <i>Tempoh :</i></p> <p>From : <u>April 2013</u> <i>Dari :</i></p> <p>To : <u>March 2016</u> <i>Hingga :</i></p>
<p>5.0</p>	<p>Lokasi Projek Penyelidikan Dijalankan: <i>Location where the Project will be carried out :</i></p> <ul style="list-style-type: none"> • Humanoid Robot and Bio-Sensing Center (HuRoBs), Faculty of Mechanical Engineering, Universiti Teknologi MARA, 40450 Shah Alam, Selangor. • Clinical Training Center, Faculty of Medicine, Universiti Teknologi MARA, Sungai Buloh Campus, Jalan Hospital, 47000 Sungai Buloh, Selangor. • Hospital Sungai Buloh, 47000 Sungai Buloh, Selangor.
<p>6.0</p>	<p>Keterangan bagaimana hasil kajian akan digunakan: <i>Explain how the results will be used :</i></p> <p>The result will be used for the development of the following:</p> <ul style="list-style-type: none"> a) A clinical database of upper limb spasticity in Malaysia b) A mechatronic function module of a biomimetic spastic elbow, consisting of a mechanical structure, sensors, actuators and information processing containing controllers. c) Algorithms for emulation of spasticity symptoms according to the six levels of the Modified Ashworth Scale. d) Algorithms for emulation of spasticity symptoms according to the five levels of the Tardieu Scale.

7.0 **Kaedah Penyelidikan: (Sila terangkan perkara-perkara berikut)**
Experimental : (Please explain the following)

7.1 **Rekabentuk kajian, metodologi yang diguna:**
Experimental design and methodology :

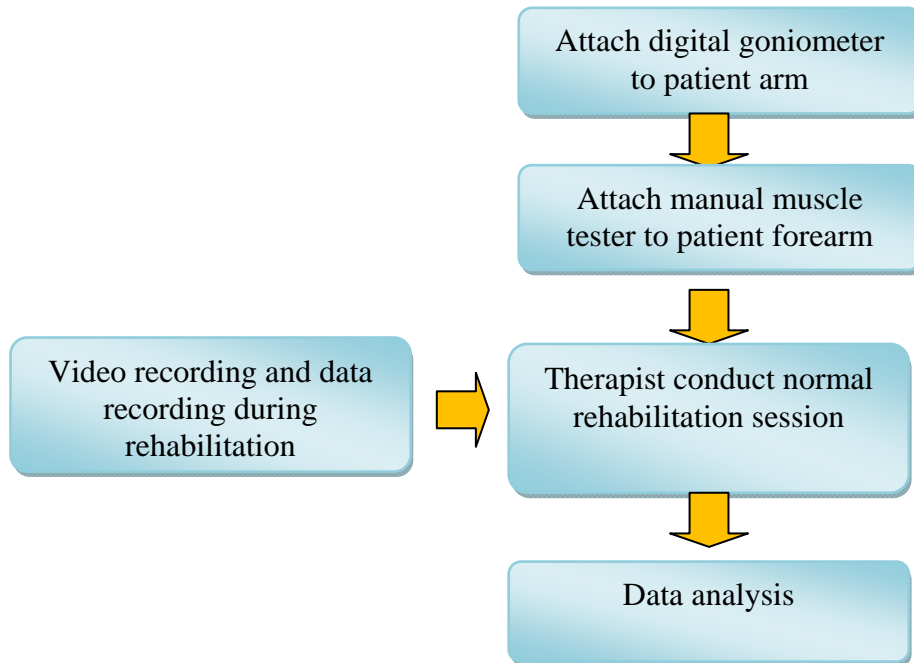

Figure 1: Flowchart of Experimental Protocol (Non-Invasive)

i. Pre-Assessment Procedure: Devices Set-Up

Prior to the assessment of patients, the devices used for the assessment, i.e. the goniometer, muscle strength meter and video recorder, must be set up carefully.

Goniometer: The patient will be attached with a goniometer to measure the angle of elbow joint during the evaluation session. The goniometer GNM-BTA from Vernier is proposed (refer Figure 2). It is important to make sure that the patient can move freely with the goniometer attached to the upper limb (refer Figure 3).

Muscle Strength Meter: The will be attached with the muscle strength meter Mobie WT-100 product of Sakai Medic to measure the force given by therapist to the upper limb disorder patient (refer Figure 4).

Video Recording: The evaluation session will be recorded for future references.



Figure 2: Goniometer - joint angle sensor attached to metal stationary arm



Figure 3: Attaching goniometer to the patient



Figure 4: Muscle Strength Meter μTAS F1

ii. Assessment Procedure: Parameters Measurement

The assessment procedure is non-invasive in nature and has nothing to do with blood. It is similar with the procedure of a therapist conducts a normal rehabilitation session to the patient suffering upper limb spasticity. The difference is that during this procedure the following parameters will be measured:

- a) Elbow joint angle of the patient
- b) Forces given by the therapist to the patient
- c) Position of the therapist and the patient

The assessment procedure involves three steps:

Slow Motion Assessment: The therapist stretches the forearm of the patient as fast as he or she could manage. A catch is expected to happen. Determine the angle θ_1 and the torque τ_1 when catch happens from the goniometer and the

muscle strength meter.

Fast Motion Assessment: The therapist stretches the forearm of the patient as slow as he or she could manage until the fully stretched position. Determine the angle θ_2 and the torque τ_2 at the fully stretched position from the goniometer and the muscle strength meter.

Evaluation of Severity Level: The difference in terms of the angular position detected during the fast and slow motion assessment can be used to determine the level of severity. Both the Tardieu Scale (refer Table 1) and the Modified Ashworth Scale (refer Table 2) will be applied.

Repeat these steps three times.

The examiner/therapist must have the skill to perform the following for the elbow joint and its motion:

- a) Position and stabilize correctly
- b) Move the forearm through the appropriate range of motion
- c) Determine the end of the range of motion
- d) Align the measuring instrument with landmarks
- e) Read the measuring instrument
- f) Record measurements correctly

Table 1: Tardieu Scale

<i>Scale</i>	<i>Description</i>
0	No resistance throughout passive movement
1	Slight resistance throughout, with no clear catch at a precise angle
2	Clear catch at a precise angle, followed by release
3	Fatigable clonus (< 10secs) occurring at a precise angle
4	Not fatigable clonus (> 10secs) occurring at a precise angle
5	Joint immobile

(Reference: http://www.health.qld.gov.au/pahospital/biru/docs/tardieu_scale.pdf)

Table 2: Modified Ashworth Scale

<i>Scale</i>	<i>Description</i>
0	No increase in muscle tone
1	Slight increase in muscle tone, manifested by a catch and release or by minimal resistance at the end of the range of motion (ROM) when the affected part(s) is moved in flexion or extension
1+	Slight increase in muscle tone, manifested by a catch, followed by minimal resistance throughout the remainder (less than half) of the ROM
2	More marked increase in muscle tone through most of the ROM, but affected part(s) easily moved
3	Considerable increase in muscle tone, passive movement difficult
4	Affected part(s) rigid in flexion and extension

(Reference: <http://www.rehabmeasures.org/PDF%20Library/Modified%20Ashworth%20Scale%20Instructions.pdf>)

iii. Post-Assessment Procedure: Data Analysis

The collected data will be analyzed in term of the angular velocity of the patient movement, characteristics of each symptoms and level after the session completes. Evaluation of the measurement reliability using standard deviation.

The proposed deadlines for the tasks listed above are:-

▼ 1: Ethics Approval	30 November 2013
▼ 2: Screening of Patients	3 December 2013
▼ 3: Assessment Sessions	30 January 2014
▼ 4: Data Analysis	25 February 2014

7. Saiz sampel, kriteria pemilihan:
2 Sample size and selection criteria :

The sample size required is estimated at 97 subjects. The calculation using PS-power and sample size calculation software.

The inclusion criteria for the screening of patients include the following:

- a) Adult above 18 years old
- b) Diagnosis of central nerve system disorders
- c) Consent of care giver
- d) Ability to understand and follow commands

It involves interviewing and examining the subject and reviewing records to obtain an accurate description of current symptoms; functional abilities; and medical history.

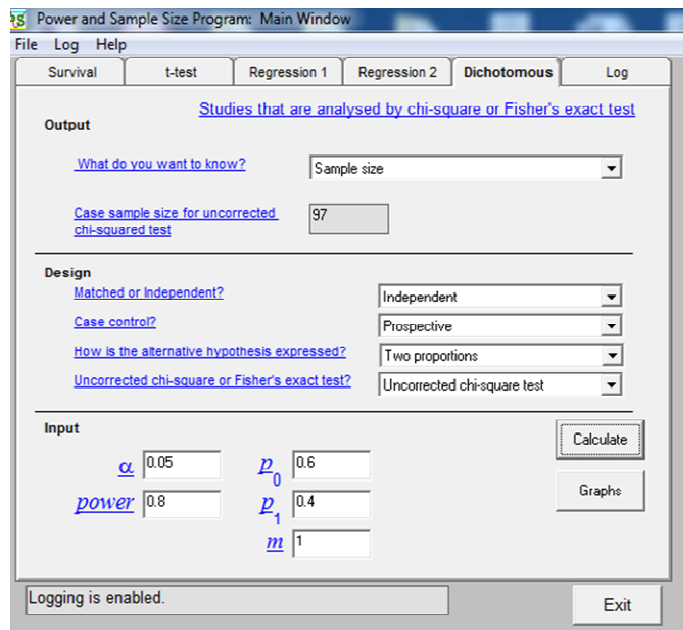

Figure 6: Sample Size Calculation

7. 3	Pembahagian kumpulan ujian dan kontrol; dan ciri-ciri kohort atau sampel dan jenis kontrol: <i>Division of test and control groups, cohort properties or samples, and type of control :</i> N/A
7. 4	Pemerosesan data dan penganalisaan statistical: <i>Data processing and statistical analysis :</i> Results will subject to reporting as a case study analysis.

Bahagian C: Peruntukan *Part C : Research grant*

Geran projek: *Ada/ Tiada*
Project Grant : *Already-obtained/ Not obtained yet*

Jika ada, nyatakan yang berikut:
If obtained, please state :

Jumlah peruntukan:
Total allocation :

Jangkamasa peruntukan :
Duration of grant :

APPLICATION FOR RESEARCH ETHICS APPROVAL

PART E: ETHICAL ISSUES QUESTIONNAIRE

Principal Researcher :	Dr.-Ing Low Cheng Yee	
Faculty :	Faculty of Mechanical Engineering	
Project Title :	Development of a Part Task Trainer for Upper Limb Spasticity	
Contact No.	017-960 5568	Signature
Email :	low.uitm@gmail.com chengyee.low@salam.uitm.edu.my	

The following questionnaire is to help alert you to the major types of ethical issues in your research. Please answer ALL questions.

If you tick 'Yes' to any of the questions, please include a brief description here and provide full details and all necessary justifications in your proposal. Please also explain and justify other ethical issues where applicable.

	SUBJECTS' PROFILE	No	Yes	Brief description
1	Please indicate your sample size and age groups.			<i>Sample size : 97</i>
2	Are any of these subjects from a particularly vulnerable group? (e.g. young children, mentally challenged etc.)		✓	They are patients who has been diagnosed with upper limb disorder with the spasticity symptoms
3	Are any of these subjects from a minority/ culturally identifiable/ disadvantaged group? (e.g. orang asli etc.)		✓	The subjects have been positively diagnosed with upper limb disorder
4	Are any of these subjects in constant requirement of / is highly dependent on medical care?		✓	The patients is undergoing the rehabilitation therapy
5	Are any of these subjects unable to give or are incapable of giving consent? (i.e. consent will be obtained indirectly from a legal guardian etc.)	✓		The subjects are adult patients and capable of giving consent
6	Are the subjects given any form of payment/ incentive to participate?	✓		

	PRIVACY AND CONFIDENTIALITY	No	Yes	Brief description
7	Will you be collecting data that will potentially disadvantage a subject? (e.g. <i>handicaps etc.</i>)	✓		
8	Does any of the data that is collected has the potential to cause discomfort, embarrassment, or psychological harm to the subjects? (e.g. <i>sexual orientation etc.</i>)	✓		
9	Does your research involve measures undeclared to the subjects? (e.g. <i>covert observations etc.</i>)	✓		
10	Will the collected data be made available to other parties not involved in the research? (e.g. <i>govt agencies</i>)	✓		Only the co-researcher institution have the right to use the data collected

	RISK OF HARM	No	Yes	Brief description
11	Will you be collecting biological samples e.g. body fluids? (if 'No', go to Question 14)	✓		
12	What type of biological samples? (Please indicate amount and frequency)			N/A
13	Is the collection method invasive and has the potential to cause harm, physical pain or discomfort etc.?			N/A
14	Will the subjects be subjected to physically invasive examinations or exercise regimens?		✓	Subjects will be attached with a goniometer at the upper limb and require to do usual rehabilitation session with experience therapist
15	Is there any form of novel procedure/ medication involved?		✓	The procedure shall involves the goniometer and muscle strength meter
16	If 'Yes' to No.15, and an effective treatment is already available, is a placebo group included and justified?	✓		
17	Is there any kind of risk to the subject if he/she chose to withdraw?	✓		

	OTHER ETHICS ISSUES	No	Yes	Brief description
18	Are there any other ethical issues not highlighted in this checklist?	✓		



FAKULTI KEJURUTERAAN MEKANIKAL
UNIVERSITI TEKNOLOGI MARA

INVESTIGATOR CURRICULUM VITAE

NOOR AYUNI CHE ZAKARIA

Name :	NOOR AYUNI BINTI CHE ZAKARIA
Faculty :	FAKULTI KEJURUTERAAN MEKANIKAL
Staff No :	258098
Grade of Position (VK7/DM54/DM52 etc)	DM 45
Pasport/MyKad No. :	840131-03-5388
Telephone No. (Office)	-
Cell-phone :	014-549-5900
Email	ayuni8098@salam.uitm.edu.my ayuni.uitm@yahoo.com

BASIC PROFILE

Lecturer DM45/DM46/DM51/DM52/DM53/DM54

Appointments	Date/Year of Appointment
Lecturer DM45/DM46	1 JULAI 2009
Lecturer DM52/DM51	-
Lecturer DM53/DM54/DT1	-
Professor (VK7)	-
Professor (VK6)	-
Year of Birth :	1984
Ph.D Qualification (Year Obtained)	-
Professional Qualification (Year Obtained)	-

RESEARCH FUNDINGS *(State whether Principal/Co-Researcher)*

NATIONAL LEVEL ACTIVE RESEARCH FUNDING (MOSTI/FRGS & Others) (Last Five Years)

	Research Project	Source	Total Funds	Begin Year	End Year
1	Co-Researcher , Adaptive Control for Hybrid-Actuated Robotic Finger	FRGS	RM 40,000	2010	2012
2	Co-Researcher , A New Architecture Based on Cognitive-Reflective-Motor Loops for Self-Optimizing Mechatronic Function Modules	FRGS	RM 84,000	2010	2012

Dana Kecemerlangan UiTM (Last Five Years)

	Research Project	Total Funds	Begin Year	End Year
1	Principal Researcher , Mechatronic Design for a Fail-Safe Catheter Guide System in Blood Circulatory system	RM 6,000	2011	2012

PUBLICATIONS *(Only those indexed in IEEE/ISI/SCOPUS)*

(Please ensure that you indicate whether papers are indexed in IEEE/ISI/Scopus, also indicate the impact factor if available)

PUBLICATIONS FOR 2013

- [1] **Noor Ayuni Che Zakaria**, Takashi Komeda, Cheng Yee Low, Kaoru Inoue, Stephan Raczak, "Emulation of Spasticity Symptoms in Upper Limb Part-task Trainer for Physiotherapist Education", *Applied Mechanics and Materials*, Vol. 393 (2013), 999-1004.
- [2] **Noor Ayuni Che Zakaria**, Takashi Komeda, Cheng Yee Low, Kaoru Inoue; "High-fidelity Part-Task Trainer of Upper Limb Disorder for Physiotherapist Education", *Proceedings of the 12th International Conference on Signal Processing, Robotics and Automation ISPRA '13*, Cambridge, UK, February 20-22, 2013. Pp. 165-170 ISSN 1790-5117 ISBN 978-1-61804-164-7 **{ISI/SCOPUS}**

PUBLICATIONS FOR 2012

- [3] **Noor Ayuni Che Zakaria**, Takashi Komeda, Cheng Yee Low, Mohri Makoto, Masayuki Kobayashi, Ahmad Yusri Ismail, Roman Dumitrescu; "Development of Foolproof Catheter Guide System based on Mechatronics Design", *Prod. Eng. Res. Devel.* ISSN 0944-6524 DOI 10.1007/s11740-012-0430-6 **{SCOPUS}**
- [4] **Noor Ayuni CZ**, Takashi Komeda, Cheng Yee Low; "Design of Upper Limb Patient Simulator", *Journal of Procedia Engineering*, Volume 41, 2012, Pages 1374-1378. DOI: 10.1016/j.proeng.2012.07.324 **{SCOPUS}**
- [5] Cheng Yee Low, Rosdayanti Fua-Nizan, Khairul Azmi, **Noor Ayuni CZ**; "Steering Behaviour of a Track-Driven Paintball Robot", *Journal of Procedia Engineering*, Volume 41, 2012, Pages 1516-1523. DOI: 10.1016/j.proeng.2012.07.344 **{SCOPUS}**

PUBLICATIONS FOR 2010

- [1] **Noor Ayuni CZ**, Cheng Yee Low, Takashi Komeda; "Mechatronic Design for A Fail-Safe Catheter Guide System", *Proceedings of ASME Congress & Exposition IMECE2010*, Vancouver, BC, CA, Nov.12-18, 2010. ISBN 978-0-7918-3891, IMECE2010-37634. **{SCOPUS}**



FAKULTI KEJURUTERAAN MEKANIKAL
UNIVERSITI TEKNOLOGI MARA

INVESTIGATOR CURRICULUM VITAE

Name :	Low Cheng Yee
Faculty :	Faculty of Mechanical Engineering, UiTM
Staff No :	190305
Grade of Position (VK7/DM54/DM52 etc)	DM52 (Senior Lecturer)
Pasport/MyKad No. :	800901-06-5545
Telephone No. (Office)	03-55436276
Cell-phone :	017-9605568
Email	low.uitm@gmail.com

BASIC PROFILE

Lecturer DM45/DM46/DM51/DM52/DM53/DM54

Appointments	Date/Year of Appointment
Lecturer DM45/DM46	02 December 2004
Lecturer DM52/DM51	26 July 2011
Lecturer DM53/DM54/DT1	
Professor (VK7)	
Professor (VK6)	
Year of Birth :	1980
Ph.D Qualification (Year Obtained)	2009
Professional Qualification (Year Obtained)	

RESEARCH FUNDINGS

NATIONAL LEVEL ACTIVE RESEARCH FUNDING (MOSTI/FRGS & Others) (Last Five Years)

	Research Project	Source	Total Funds	Begin Year	End Year
1	Principal , A New Architecture based on Cognitive—Reflective—Motor Loops for Self-Optimizing Mechatronic Function Modules. Grant number: 600-RMI/ST/FRGS 5/3/Fst (256/2010)	FRGS	RM 84,000	2010	2012
2	Principal , Behavioral Self-Optimization using Distributed Cognitive—Reflective—Motoric Loops for Networked Mechatronic Systems, Grant number: ERGS/1/2011/TK/UITM/03/76	ERGS	RM58,000	2011	2013
3	Co-Researcher , Adaptive Control for Hybrid-Actuated Robotic Finger. Grant number: 600-RMI/ST/FRGS 5/3/Fst(109/2010).	FRGS	RM40,000	2010	2012
4	Co-Researcher , New Intelligent Tactile Sensor Principle using Single Miniature Sensing Element based on Optical Waveguide Transduction Method. Grant number: 600-RMI/ST/FRGS 5/3/Fst(86/2010)	FRGS	RM48,000	2010	2012
5	Co-Researcher , Integration of Human-Robot Interaction (HRI) Architecture in Therapy Model of Children with Autism Spectrum Disorders (ASD), Grant number: 600-RMI/ST/FRGS 5/3/Fst (31/2011)	FRGS	RM198,400	2011	2013

INTERNATIONAL RESEARCH FUNDING INCLUDING CONTRACT RESEARCH (Last Five Years)

	Research Project	Source	Total Funds	Begin Year	End Year
1	Associate Researcher , Subproject B2 of the Collaborative Research Centre 614 "Self-Optimizing Concepts and Structures in Mechanical Engineering". Grant number: SFB 614	German Research Foundation (DFG)	EUR478,400	2006	2008

Dana Kecemerlangan UiTM (Last Five Years)

	Research Project	Total Funds	Begin Year	End Year
1	Co-Researcher , Mechatronic Design for a Fail-Safe Catheter Guide in Blood Circulatory System, Grant number: 600-RMI/ST/DANA 5/3/Dst (145/2011)	RM6,000	2011	2012
2	Principal , Development of a Hybrid-Actuated Robotic Finger with Adaptive Control. Grant number: 600-RMI/ST/DANA 5/3/Dst(179/2009).	RM10,000	2010	2011

PUBLICATIONS (*Only those indexed in IEEE/ISI/SCOPUS*)

PUBLICATIONS FOR 2012

- [1] N.A. Che Zakaria, T. Komeda, **C. Low**, M. Makoto, M. Kobayashi, A.Y. Ismail, R. Dumitrescu, "Development of Foolproof Catheter Guide System based on Mechatronic Design", Production Engineering Research and Development, Springer, 2012
- [2] **C. Low**, M. Aldemir, N. Aziz, R. Dumitrescu, H. Anacker, M. Mellado, "Strategy Planning of Collaborative Humanoid Soccer Robots based on Principle Solution", Production Engineering Research & Development,, Springer, 2012
- [3] C. Oh, K. Choong, **C. Low**, "Biotensegrity Inspired Robot – Future Construction Alternative", Procedia Engineering, Volume 41, 2012, Elsevier
- [4] **C. Low**, F. Rosdayanti, K. Azmi, N.A. Che Zakaria, "Steering Behavior of a Track-Driven Paintball Robot", Procedia Engineering, Volume 41, 2012, Elsevier
- [5] **C. Low**, M. Aldemir, N. Aziz, R. Dumitrescu, H. Anacker, M. Mellado, "Principle Solution for Designing Collaborative Humanoid Soccer Robots, Procedia Engineering", Volume 41, 2012, Elsevier
- [6] N.A. Che Zakaria, T. Komeda, **C. Low**, "Design of Upper Limb Patient Simulator", Procedia Engineering, Volume 41, 2012, Elsevier
- [7] Armansyah , A. Jaffar, **C. Low**, S. Kasolang, N.H. Saad, B.D. Kuncoro, "Wireless e-Nose Sensor Node: State-of-the-Art", Procedia Engineering, Volume 41, 2012, Elsevier
- [8] A.A. Ahmad, T. Koch, A. Jaffar, M.S. Bahari, **C. Low**, "Resistivity Characteristics of Piezoresistive Based Transduction Tactile Sensing Using Pressure Sensitive Conductive Rubber Sheet", Joint Symposium on System-Integrated Intelligence, Hannover, Germany, June 27-29, 2012
- [9] **C. Low**, M.A. Kasim, M.F. Mansur, R. Jaafar, A. Jaffar, "Evaluation of Shape Memory Alloy Wire for Applications in Hand Prosthesis", Joint Symposium on System-Integrated Intelligence, Hannover, Germany, June 27-29, 2012
- [10] R. Jaafar, N. Jamil, A. Jaffar, **C. Low**, "An Integral Automation of Industrial Fruit for Grading and Sorting using Machine Vision", Joint Symposium on System-Integrated Intelligence, Hannover, Germany, June 27-29, 2012
- [11] A.A. Ahmad, T. Koch, A. Jaffar, M.S. Bahari, **C. Low**, "Resistivity Characteristics of Single Miniature Tactile Sensing Element Based on Pressure Sensitive Conductive Rubber Sheet", IEEE 8TH International Colloquium on Signal Processing & Its Applications(CSPA 2012), Malacca, Malaysia, March 23-25, 2012
- [12] **C. Low**, M. A. Kasim, M. F. Mansur, K. Ng, A. Jaffar, T. Koch, "Design of a Hybrid-Actuated Finger Prosthesis with Tactile Sensing", 11th WSEAS International Conference on Signal Processing, Robotics and Automation, Cambridge, UK, February 22-24, 2012

PUBLICATIONS FOR 2011

- [1] R. Jaafar, N. Jamil, A. Jaffar, **C. Low**, "Assessment of Palm Oil Fresh Fruit Bunches using Photogrammetric Grading System", International Food Research Journal, Volume 18, Issue 3, 2011
- [2] M.S. Bahari, A. Jaffar, **C. Low**, R. Jaafar, K. Roese, H. Yussof, "Design and Development of Multifingered Prosthetic Hand", International Journal of Social Robotics, Springer, DOI: 10.1007/s12369-011-0133-8
- [3] A. Jaffar, M. S. Bahari, **C. Low**, R. Jaafar, "Design and Control of Multifingered Anthropomorphic Robotic Hand", International Journal of Mechanical and Mechatronics Engineering, Volume 11, Issue 4, 2011
- [4] R. Jaafar, N. Jamil, A. Jaffar, **C. Low**, "Assessment of Palm Oil Fresh Fruit Bunches using Photogrammetric Grading System", International Food Research Journal, Volume 18, Issue 3, 2011
- [5] C. Kang, J. Tan, L. Pan, **C. Low**, A. Jaffar, "Numerical and experimental investigations of splat geometric characteristics during oblique impact of plasma spraying", Applied Surface Science, Volume 257, Issue 24, 1 October 2011, Pages 10363–10372

PUBLICATIONS FOR 2010

- [1] Noor Ayuni Che Zakaria, **Cheng Yee Low**, Takashi Komeda: Mechatronic Design for a Fail-Safe Catheter Guide System, In proceedings of ASME 2010 International Mechanical Engineering Congress & Exposition, November 12-18, Vancouver, British Columbia, Canada, 2010
- [2] **Low, C.**: A Methodology to Manage the Transition from the Principle Solution towards the Controller Design of Advanced Mechatronic Systems. PhD Dissertation, Faculty of Mechanical Engineering, Paderborn University, HNI-Verlagsschriftenreihe, Band 254, Paderborn, 2010, ISBN-Number 978-3-939350-73-6
- [3] **Low Cheng Yee**, Ahmed B Jaffar, Roseleena Binte Jaafar, Hafizan Hashim, Mohd Faizal Md Abdul Mansur: Mechatronic Design of a Prosthetic Finger with Hybrid Mechanism, In proceedings of 2010 International Symposium on Robotics and Intelligent Sensors — IRIS2010, March 8-11, Nagoya, Japan, 2010
- [4] Roseleena Binte Jaafar, **Low Cheng Yee**, Mohd Azlan Yusof: Robotic Hand Design with Kinematics Analysis, In proceedings of 2010 International Symposium on Robotics and Intelligent Sensors — IRIS2010, March 8-11, Nagoya, Japan, 2010
- [5] Roseleena Binte Jaafar, **Low Cheng Yee**, Mohamad Asyraf Othoman: Development & Prototyping of a 3DOF Anthropomorphic Hand, In proceedings of 2010 International Symposium on Robotics and Intelligent Sensors — IRIS2010, March 8-11, Nagoya, Japan, 2010
- [6] Ahmed B Jaffar, Roseleena Binte Jaafar, **Low Cheng Yee**, Mohd Saiful Bahari, Kolja Roesse: Design and Development of Algorithmic Control System for Anthropomorphic Multifingered Prosthetic Hand, In proceedings of 2010 International Symposium on Robotics and Intelligent Sensors — IRIS2010, March 8-11, Nagoya, Japan, 2010
- [7] Muhammad Azmi Ayub, **Cheng Yee Low**, Ahmad Fazli Mohd Kamil: A Study on Steerability of Tracked Unmanned Ground Vehicles, In proceedings of 2010 International Symposium on Robotics and Intelligent Sensors — IRIS2010, March 8-11, Nagoya, Japan, 2010

PUBLICATION FOR 2009

- [1] Ahmed Jaffar, Roseleena Jaafar, Nursuriati Jamil, **Cheng Yee Low**, Bulan Abdullah: Photogrammetric Grading of Oil Palm Fresh Fruit Bunches. In: International Journal of Mechanical & Mechatronics Engineering Volume 09 Issue 10, England, U.K., 10th December 2009

PUBLICATIONS FOR 2008

- [1] Gausemeier, J.; Kahl, S.; **Low, C.**; Schulz, B.: From the Principle Solution towards Controller Design of Self-Optimizing Systems. In: Proceedings of the 7th International Heinz Nixdorf Symposium, February 20-21, Paderborn, Germany, 2008
- [2] Gausemeier, J.; Kahl, S.; **Low, C.**; Schulz, B.: Systematic Development of Controller Design Based on the Principle Solution of Self-Optimizing Systems. In: Proceedings of the 10th International Design Conference — DESIGN 2008, May 19-22, Dubrovnik, Croatia, 2008
- [3] Gausemeier, J.; **Low, C.**; Steffen, D.; Deyter, S.: Specifying the Principle Solution in Mechatronic Development Enterprises. In: Proceedings of the 2nd IEEE International Systems Conference — SysCon 2008, April 7-10, Montreal, Canada, 2008

PUBLICATIONS FOR 2007

- [1] Gausemeier, J.; Frank, U.; **Low, C.**; Henke, C.: From Domain-Spanning Conceptual Design to Domain-Specific Controller Design of Self-Optimizing Systems. In: Proceedings of the Systems Engineering for Future Capability, February 12-13, Loughborough, UK, 2007
- [2] Gausemeier, J.; Frank, U.; **Low, C.**; Henke, C.: Synergistic Impact of Domain-Spanning Conceptual Design on Control of Self-Optimizing Systems. In: Proceedings of the 1st IEEE International Systems Conference — SysCon 2007, April 9-12, Honolulu, USA, 2007



FAKULTI KEJURUTERAAN MEKANIKAL
UNIVERSITI TEKNOLOGI MARA

INVESTIGATOR CURRICULUM VITAE

FAZAH AKHTAR BT HANAPIAH

Name :	Fazah Akhtar Bt. Hanapiah
Faculty :	Faculty of Medicine
Staff No :	0279637
Grade of Position (VK7/DM54/DM52 etc)	DU54
Pasport/MyKad No. :	720412-10-5622
Telephone No. (Office)	03-61265307
Cell-phone :	013-2152468
Email	fazahakhtar@yahoo.com

BASIC PROFILE

Lecturer DM45/DM46/DM51/DM52/DM53/DM54

Appointments	Date/Year of Appointment
Lecturer DM45/DM46	
Lecturer DM52/DM51	2nd August 2010
Lecturer DM53/DM54/DT1	26th November 2011
Professor (VK7)	
Professor (VK6)	
Year of Birth :	12th April 1972
Ph.D Qualification (Year Obtained)	Masters Degree M.Rehab.Med (UM) (2009)
Professional Qualification (Year Obtained)	MBBCh.BAO.LRCP&SI (NUI) (1996)

RESEARCH FUNDINGS (State whether Principal/Co-Researcher)

NATIONAL LEVEL ACTIVE RESEARCH FUNDING (MOSTI/FRGS & Others) (Last Five Years)

	Research Project	Source	Total Funds	Begin Year	End Year
1	Human-Robot Interaction (HRI) Algorithm in Robot-Based Intervention of Children with Autism Spectrum Disorders (ASD): Co-Researcher (600-RMI/FRGS 5/3/Fst (31/2011))	FRGS	RM 198,400.00	2011	2013
2	Dynamic Visual Reminiscence Therapy Theory in Alzheimer Psychosocial Treatment : Co-Researcher (600-RMI/ERGS 5/3 (74/2012))	ERGS	RM 50,000.00	2012	2014

Dana Kecemerlangan UiTM (Last Five Years)

	Research Project	Total Funds	Begin Year	End Year
1	Principle Investigator: Correlation of Early Magnetic Resonance Imaging Findings in Chronic Traumatic Spinal Cord Injured Patients with Lower Limb Spasticity (600-RMI/DANA 5/3/RIF (11/2012))	RM 32,000.00	2012	2014
2				

PUBLICATIONS (Only those indexed in IEEE/ISI/SCOPUS)

(Please ensure that you indicate whether papers are indexed in IEEE/ISI/Scopus, also indicate the impact factor if available)

1. Kit Mun Tan, **Fazah Hanapiah**, Catherine Cornell, Catriona Begley, Aisling Weyham, Jacinta McElligot: Intrathecal Baclofen Pump in the Management of Severe Spasticity. 55th Annual Scientific Meeting of the Irish Gerontology Society. *Irish Journal of Medical Science* 2007; 176(6):S259-260. (SCOPUS)
2. Syed Tajuddin Syed Hassan, Husna Jamaludin, Latifah Abdul Latif, Mohd Norzi Ghazali, Mohd Yusoff Adon, Rosna Abdul Rahman, **Fazah Akhtar Hanapiah**, Ali Khalid. Traumatic Brain Injury Caregiving and Rehabilitation: Pragmatic and Innovative Mind Mending Strategies. 5th International Online Medical Conference. March 2012 (SCOPUS)
3. Hanafiah Yussof, Luthffi Idzhar Ismail, Syamimi Shamsuddin, **Fazah Akhtar Hanapiah**, Salina Muhamed, Hanizah Ali Piah. Initial Response of Autistic Children in Human-Robot Interaction Therapy with Humanoid Robot NAO. Full Paper. 2012 IEEE 8th International Colloquium on Signal Processing and its Applications (CSPA 2012)188-193.(IEEE)
4. Wan Ahmad Azzat Wan Zaidi, A'qilah Baharudin, Yusanita Jamalut, Bashirah Mohd Nor, Farah Hazwani Zulkapli, **Fazah Akhtar Hanapiah**. Quality of Life Amongst HIV Positive Patients in Malaysian HIV Shelter Homes. *Procedia Social and Behavioral Sciences* 2012;35:213-220 (ISI / SCOPUS)
5. **F.Hanapiah**, Abdul Rahim R, Khazri L, Ali PiahH. Posttraumatic Amnesia in Acute Care. 7th World Congress for Neurorehabilitation. Melbourne Australia 2012. Poster Abstracts. *Neurorehabilitation and Neural Repair* 2012 26(6):781-782 (ISI:IF 4.495)
6. Luthffi Idzhar Ismail, Syamimi Shamsuddin, Hanafiah Yusoff, **Fazah Akhtar Hanapiah**, Nur Ismarrubie Zahari. Estimation of Concentration by Eye Contact Measurement in Robot-based Intervention Program with Autistic Children. *Procedia Engineering* 2012;41:1548-1552(SCOPUS)
7. Syamimi Shamsuddin, Hanafiah Yusoff, Luthffi Idzhar Ismail, Salina Mohamed, **Fazah Akhtar Hanapiah**, Nur Ismarrubie Zahari. Humanoid Robot NAO Interacting with Autistic Children of Moderately Impaired Intelligence to Augment Communication Skills. *Procedia Engineering* 2012;41:1533-1538(SCOPUS)
8. Syamimi Shamsuddin, Hanafiah Yusoff, Luthffi Idzhar Ismail, Salina Mohamed, **Fazah Akhtar Hanapiah**, Nur Ismarrubie Zahari. Initial Response in HRI- a Case Study on Evaluation of Child with Autism Spectrum Disorders Interacting with a Humanoid Robot NAO. *Procedia Engineering* 2012;41:1448-1455(SCOPUS)
9. Luthffi Idzhar Ismail, Syamimi Shamsuddin, Hanafiah Yusoff, **Fazah Akhtar Hanapiah**, Nur Ismarrubie Zahari. Robot-based Intervention Program for Autistic Children with Humanoid Robot NAO: Initial Response in Stereotyped Behaviour. *Procedia Engineering* 2012;41:1441-1447(SCOPUS)
10. Syed Tajuddin Syed Hassan, Husna Jamaludin, Latifah Abdul Latif, Mohd Norzi Ghazali, Mohd Yusoff Adon, Rosna Abdul Rahman, **Fazah Akhtar Hanapiah**, Ali Khalid. Diffuse Axonal Injury (DAI): A 9 Year Journey in Caregiving and Rehabilitation. 6th International Online Medical Conference. Nov 2012 (SCOPUS)

Subjects Information Sheet

Development of a Part Task Trainer for Upper Limb Spasticity

Introduction Study

This research is about developing a part-task trainer for therapist education, particularly for developing the psychomotor skills necessary for competency in physical therapy. Commonly used methods in estimating upper limb disorder level are some standardized method such as the Ashworth Scale (AS) and the Modified Ashworth Scale (MAS). However there are several uncontrolled factors that may affect the degree scores for each symptoms level either from the patients or the therapists themselves, such as the activity engaged by the patients before the tests and the testing position. Therefore it is essential for the rater or the therapists to have sufficient professional experience when working with these standardized methods. In order to amplify the reliability and the precision of the rating level, the therapists need to increase their quantity of clinical training and exposure to a variety of symptom levels without risking the patients as the trainee clinical training subjects. To avoid clinical training with patients, a part-task trainer that is able to recreate different levels of upper limb disorder symptoms has been considered.

With the intention of developing a part-task trainer as an alternative education tool for the therapists' trainees, a set of clinical data collection is needed to be modeled as the part-task trainer movement. Therefore, using goniometer and muscle strength meter (please refer to Figure 1 & 2), the angle of the elbow joint and the force given by the therapist during the rehabilitation session has to be recorded.



Figure 1: Attaching goniometer to the patient

Purpose of Study

The objectives of this study are:

- I. To measure the angular motion and torque characteristics of upper limb spasticity
- II. To build up a quantitative clinical database for upper limb spasticity specific for the Malaysian community
- III. To develop a part-task trainer prototype that can emulate upper limb spasticity for therapist education

Study Procedure

The study procedure that will be carried out is summarized in the flowchart below. Each patient will only have to attend to one rehabilitation session. The Occupational Therapist (OT) and/or psychologist will conduct the session following normal procedure.

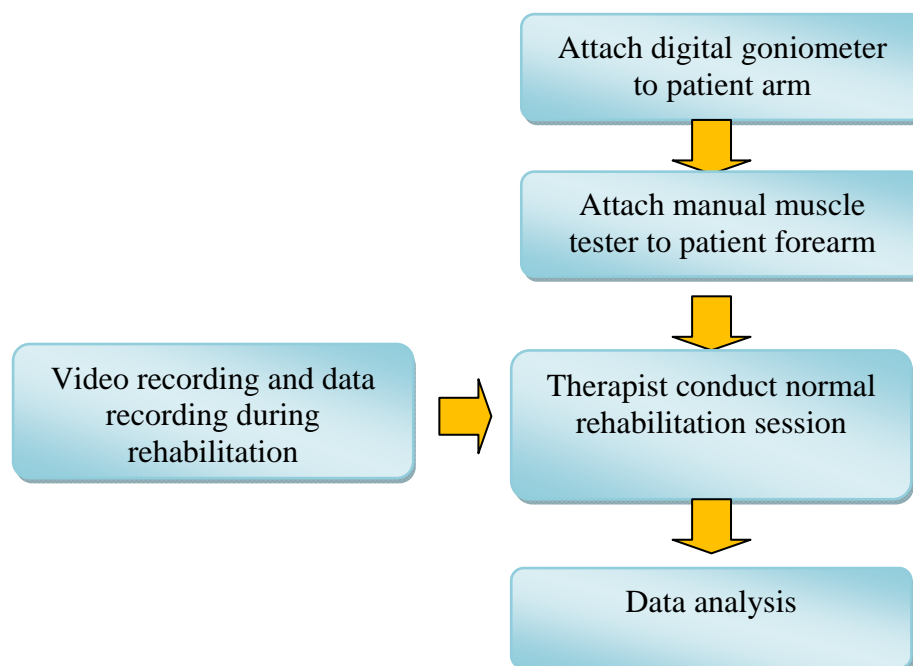

Figure 2: Flowchart of Experimental Protocol (Non-Invasive)

i. Goniometer - Elbow Angle Measurement

Based on Figure 1, the first stage signifies that the patient will be equipped with a goniometer to measure the angle of the elbow joint during the rehabilitation session. The goniometer used is a Vernier product: order code GNM-BTA (refer to Figure 3). The patient is verified that they can move freely with the goniometer attached to the upper limb (refer to Figure 1) before proceeding to the next step.



Figure 3: Goniometer - joint angle sensor attached to metal stationary arm

ii. Muscle Strength Meter

At this stage, the patient will be attach with the muscle strength meter Mobie WT-100 product of Sakai Medic to measure the force given by therapist to the upper limb disorder patient (refer to Figure 4).



Figure 4: Muscle Strength Meter μ TAS F1

iii. Evaluation Session

The therapist will conduct normal rehabilitation session to the patient depending on the patient level provided that the patient is not attending any rehabilitation session before hand on the day of experiment conducted. Each patient will experience one rehabilitation session only.

iv. Video Recording and Data Collection

The rehabilitation session of the patient will be recorded in terms of:

- Elbow joint angle of the patient during evaluation session
- Forces given by the therapist to the patient
- Position of the therapist and the patient during evaluation session

v. Data Analysis

The collected data will be analyzed in term of the angular velocity of the patient movement, characteristics of each symptoms and level after the session completes.

Participation in Study

Your participation in this study is entirely voluntary. You may refuse to take part in the study or you may withdraw yourself from participation in the study at any time without penalty.

Benefit of Study

Information obtained from this study will benefit the researchers, Government of Malaysia, doctors and individuals for the advancement of knowledge and practice of medicine and rehabilitation engineering in the future.

If you have any question about this study or your rights, please contact the investigator, Noor Ayuni Che Zakaria at telephone number +81080-4922 3010 or email at ayuni.uitm@yahoo.com and Low Cheng Yee at telephone number 017-960 5568.

Confidentiality

Your medical information will be kept confidential by the investigators and will not be made public unless disclosure is required by law.

By signing this consent form, you will authorize the review of records, analysis and use of the data arising from this study.

Consent Form

To become a subject in the research, you or your legal guardian must sign this Consent Form.

I herewith confirm that I have met the requirement of age and am capable of acting on behalf of myself /* as a legal guardian as follows:

1. I understand the nature and scope of the research being undertaken.
2. I have read and understood all the terms and conditions of my participation in the research.
3. All my questions relating to this research and my participation therein have been answered to my satisfaction.
4. I voluntarily agree to take part in this research, to follow the study procedures and to provide all necessary information to the investigators as requested.
5. I may at any time choose to withdraw from this research without giving reasons.
6. I have received a copy of the Subjects Information Sheet and Consent Form.
7. Except for damages resulting from negligent or malicious conduct of the researcher(s), I hereby release and discharge UiTM and all participating researchers from all liability associated with, arising out of, or related to my participation and agree to hold them harmless from any harm or loss that may be incurred by me due to my participation in the research.

Name of Subject/Legal Guardian

Signature

I.C No

Date

Name of Witness

Signature

I.C No

Date

Name of Consent Taker

Signature

I.C No

Date

I.C No

Date

Borang Maklumat untuk Subjek**Penciptaan Alat Latihan Simulasi klinikal untuk Spastisiti dan Ketegangan Bahagian Anggota Lengan dan Tangan****Pengenalan Kajian**

Kajian ini adalah mengenai merekabentuk sebuah alat latihan simulasi klinikal untuk ahli terapi pelatih. Antara kaedah-kaedah yang biasa digunakan untuk menganggar paras kerosakan anggota lengan dan tangan adalah beberapa kaedah yang telah diseragamkan seperti Skala Ashworth (AS), Skala Ashworth yang diubahsuai (MAS) dan Skala Tardieu. Walaubagaimanapun, terdapat beberapa faktor di luar kawalan yang mungkin menjejaskan markah evaluasi untuk setiap tahap gejala samada daripada pesakit atau ahli terapi sendiri seperti aktiviti yang dijalani pesakit sebelum ujian dan kedudukan ketika kajian. Oleh itu, ia adalah penting untuk penilai ataupun ahli terapi untuk mempunyai pengalaman professional mencukupi apabila mengendalikan kaedah-kaedah yang telah diseragamkan ini. Untuk mengukuhkan lagi kesahihan dan ketepatan tahap penilaian, ahli terapi perlu meningkatkan kualiti latihan klinikal dan pendedahan kepada pelbagai tahap gejala tanpa mejejaskan pesakit-pesakit sebagai subjek latihan klinikal para pelatih. Untuk mengelakkan latihan klinikal bersama pesakit-pesakit, sebuah alat latihan simulasi klinikal yang mampu menghasilkan semula tahap kerosakan anggota lengan dan tangan yang berbeza telah dipertimbangkan untuk kajian selanjutnya.

Dengan tujuan mencipta sebuah alat latihan simulasi klinikal sebagai suatu alat pendidikan alternatif untuk ahli terapi pelatih, satu set koleksi data klinikal perlu dimodelkan sebagai asas pergerakan alat latihan simulasi klinikal. Oleh itu, dengan menggunakan goniometer dan meter kekuatan otot (sila rujuk Rajah 1 & 2), sudut sendi siku dan daya yang dikenakan oleh ahli terapi sewaktu sesi rehabilitasi perlu direkodkan.

**Rajah 1: Pemasangan goniometer kepada pesakit**

Tujuan Kajian

Objektif kajian ini adalah :

- I. Untuk menilai ciri-ciri kerosakan anggota lengan dan tangan menggunakan goniometer dalam pengukuran sendi siku dan meter kekuatan otot sewaktu sesi rehabilitasi
- II. Untuk membandingkan ciri-ciri setiap gejala kerosakan anggota lengan dan tangan dengan penggunaan Skala Ashworth yang diubahsuai (MAS) dan Skala Tardieu dalam penganggaran tahap gejala
- III. Untuk membina pangkalan data gejala-gejala asas spastisiti dan ketegangan (lead-pipe dan cogwheel) untuk tujuan merekabentuk alat latihan simulasi klinikal

Prosedur Eksperimen

Prosedur eksperimen yang akan dijalankan ini telah dirumuskan dalam carta alir dibawah. Setiap pesakit hanya perlu menghadiri satu sesi rehabilitasi. Ahli terapi carakerja (OT) dan/atau ahli fisioterapi akan mengendalikan sesi rehabilitasi mengikut prosedur normal.

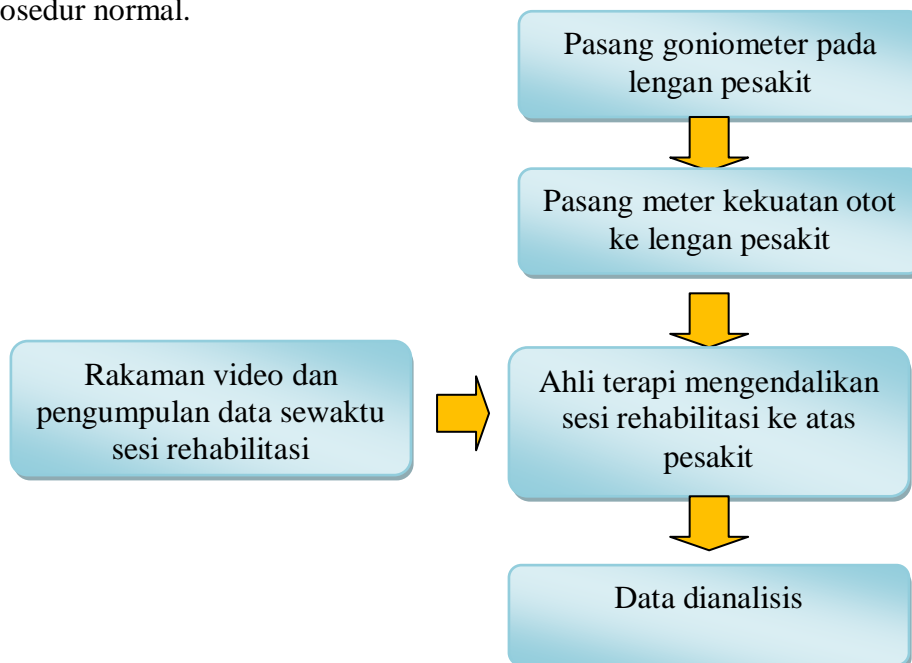

Rajah 2: Carta alir Protokol eksperimen

i. Goniometer- Pengukuran Sudut Sendi Siku

Berdasarkan Rajah 1, peringkat pertama menentukan bahawa pesakit akan dilengkapi oleh sebuah goniometer untuk mengukur sudut sendi siku sewaktu sesi rehabilitasi. Goniometer yang digunakan adalah produk Vernier: kod pesanan GNM-BTA (rujuk Rajah 4). Pesakit dipastikan bahawa mereka boleh bergerak bebas dengan pemasangan goniometer pada anggota lengan dan tangan (rujuk Rajah 1) sebelum meneruskan ke peringkat yang seterusnya.



Rajah 3: Goniometer- pengesanan sudut sendi dipasangkan kepada lengan statik logam

ii. Meter Kekuatan Otot

Pada peringkat ini, pesakit akan dipakaikan meter kekuatan otot Mobie WT-100 yang merupakan produk Sakai Medic untuk mengukur daya yang dikenakan oleh ahli terapi ke atas pesakit (rujuk Rajah 4).



Rajah 4: Meter Kekuatan Otot Mobie WT-100

iii. Sesi Rehabilitasi

Ahli terapi akan mengendalikan sesi rehabilitasi normal ke atas pesakit bergantung kepada tahap pesakit dengan syarat bahawa pesakit tidak mengikuti sebarang sesi rehabilitasi sebelum itu pada hari eksperimen dijalankan. Setiap pesakit akan melakukan satu sesi rehabilitasi sahaja melibatkan tiga pergerakan – **regangan perlahan, regangan pantas dan MRC daya kekuatan.**

iv. Rakaman Video dan Pengumpulan Data

Sesi rehabilitasi para pesakit akan dirakam dari segi:

- a) Sudut sendi siku pesakit sewaktu sesi rehabilitasi
- b) Daya yang dikenakan oleh ahli terapi kepada pesakit bergantung kepada tahap MAS dan Tardieu
- c) Kedudukan ahli terapi dan pesakit sewaktu sesi rehabilitasi

v. Data Dianalisis

Data yang telah dikumpulkan akan dianalisis dari segi halaju sudut pergerakan pesakit, ciri-ciri setiap gejala dan tahap selepas sesi selesai.

Penyertaan dalam Kajian

Penyertaan anda dalam kajian ini adalah secara keseluruhannya sukarela. Anda berhak menolak tawaran ini atau menarik diri daripada kajian ini pada bila-bila masa tanpa sebarang penalti.

Manfaat Kajian

Maklumat yang dikumpulkan dari kajian ini akan memanfaatkan penyelidik kajian ini, Kerajaan Malaysia, doktor dan individu dalam kemajuan ilmu dan amalan perubatan dan kejuruteraan rehabilitasi pada masa hadapan.

Sekiranya anda mempunyai sebarang pertanyaan mengenai kajian ini atau hak-hak anda, sila hubungi penyelidik, Noor Ayuni Che Zakaria di talian +81080-4922 3101 atau email ke ayuni.uitm@yahoo.com dan Low Cheng Yee di talian 017-960 5568.

Kerahsiaan

Maklumat perubatan anda akan dirahsiakan oleh penyelidik dan tidak akan didedahkan kepada umum melainkan jika ia dikehendaki oleh undang-undang.

Dengan menandatangani borang persetujuan ini, anda membenarkan penelitian rekod, penganalisaan dan penggunaan data hasil dari kajian ini.

Borang Persetujuan

Untuk menertai kajian ini, anda atau penjaga sah anda mesti menandatangani Borang Persetujuan ini.

Saya dengan ini mengesahkan yang saya telah memenuhi syarat umur dan dalam keadaan yang berkeupayaan untuk bertindak untuk diri sendiri/ *sebagai penjaga yang sah dalam perkara-perkara yang berikut:

1. Saya memahami ciri-ciri dan skop kajian ini.
2. Saya telah membaca dan memahami semua syarat penyertaan kajian ini.
3. Saya berpuas hati dengan jawapan pada kemusykilan saya tentang kajian ini.
4. Saya secara sukarela bersetuju menyertai kajian ini dan mengikuti segala atur cara dan memberi maklumat yang diperlukan kepada penyelidik seperti yang dikehendaki.
5. Saya boleh menarik diri daripada kajian ini pada bila-bila masa tanpa memberi sebab.
6. Saya telah pun menerima satu salinan Borang Maklumat dan Borang Izin.
7. Kecuali kecederaan yang disebabkan kelalaian dan kecuaiian oleh penyelidik, saya dengan ini melepaskan dan menggugurkan UiTM dan semua penyelidik dari semua laibiliti berhubung dengan, wujud dari atau berkaitan dengan penyertaan saya dan bersetuju untuk menjadikan mereka tidak bertanggungggan terhadap apa-apa kerugian atau kecederaan yang mungkin akan saya tanggung disebabkan penyertaan saya.

Nama Subjek/Penjaga Sah

Tandatangan

No. Kad Pengenalan

Tarikh

Nama Saksi

Tandatangan

No. Kad Pengenalan

Tarikh

Nama Pengambil Izin

Tandatangan

No. Kad Pengenalan

Tarikh